

MODULAR SYSTEM FOR ELECTRIC ACTUATORS



Electric quarter turn actuators series E 65 - E 210 with modular system are designed to automate control valves.

TECHNICAL DATA

Nominal torque:	100 Nm to 4000 Nm
Protection class:	IP67
Duty cycle:	up to Class C (max.1200 c/n) acc. to prEN 15714-2
Limit switches:	max. 250V AC, 3A
Torque control:	directional contact, max. 250V AC 5A
Switch box heater:	supply 230V AC permanently, 5W
Potentiometer:	1000 Ω
Current feedback:	4-20mA, supply max. 30V DC
Thermal motor switch:	integrated
Insulation class:	F
Corrosion protection Class:	C4 acc. to prEN 15714-2, tested acc. to EN 60068-2-52
Cable entries:	4 x M20 x 1,5 \varnothing -min = 6 mm \varnothing -max = 13 mm
Operation temperature:	-20°C to +70°C
Hand wheel:	15 revolutions 90°
Hand wheel Torque:	4 Nm for E65 20 Nm for E110 35 Nm for E160 50 Nm for E210
Supply voltage:	from 110V AC/1~ to 480V AC/3~

GENERAL APPLICATIONS

- Integrated torque control
- Digital control input
- Integrated 24V DC control voltage supply
- 5 digital feedback signals
- Switch box heater
- Prepared for further options
- Actuator mounting and optional modules as modular system
- Self-locking, separately capsuled worm gear ensures a safe positioning of the actuating element
- Top flange acc. to EN ISO 5211
- Replaceable shaft notch enables the adaption of different valves
- The optical position indicator shows the exact position of the actuating element



Complete equipment with additional board for positioner.

DIMENSIONS MODULAR SYSTEM

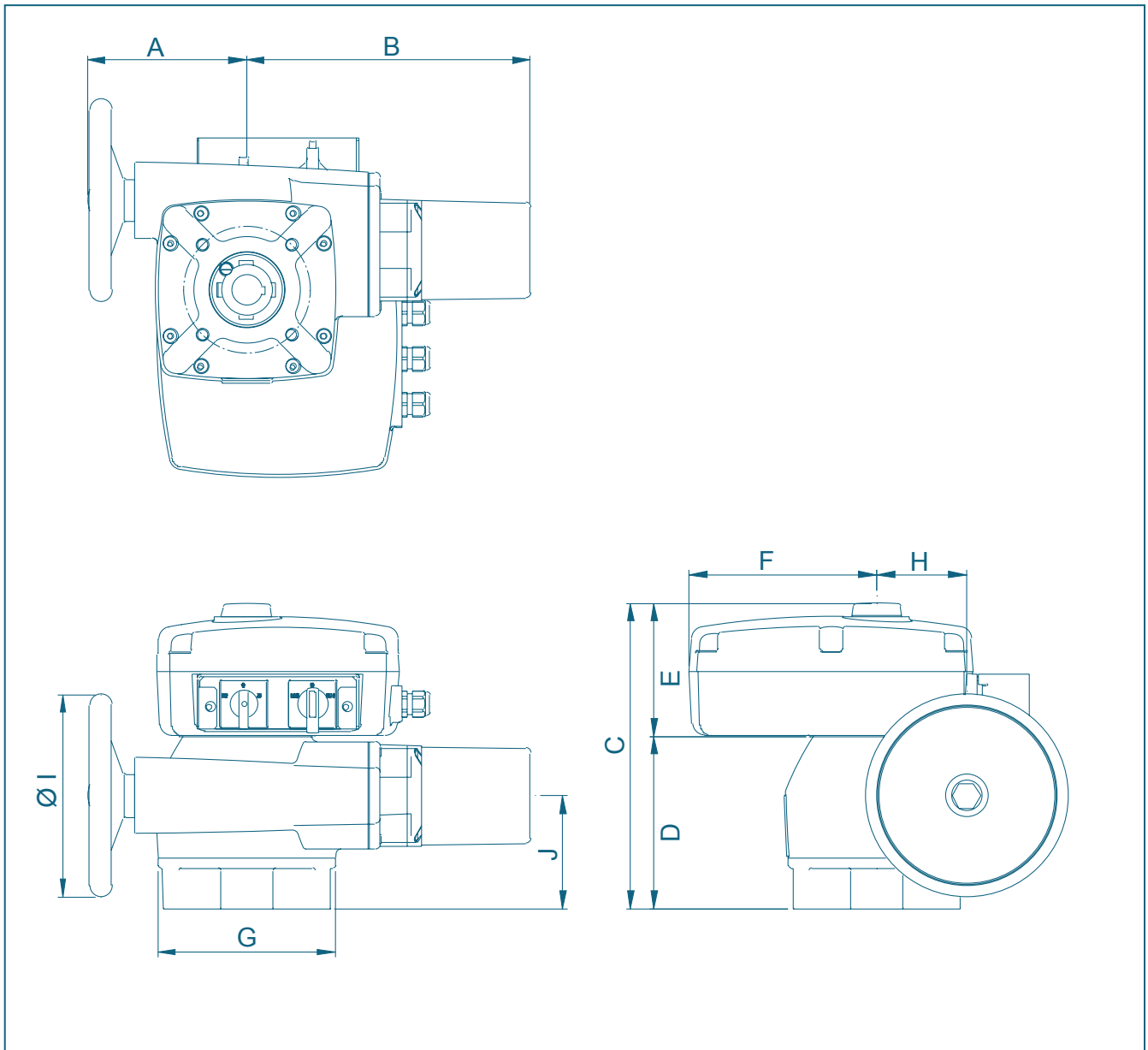

Type	Dimensions [mm]										Top flange
	A	B	C	D	E	F	G	H	ØI	J	
E 65	119	171	255	123	132	185	125	42	80	78	F04, F05, F07
E 110	136	247	277	145	132	190	150	58	125	88	F07, F10
E 160	157	280	302	170	132	185	175	89	200	112	F10, F12, F16
E 210	212	352	294	162	132	185	240	125	315	84	F12, F14, F16

Subject to change without notice

MODULAR MOUNTING

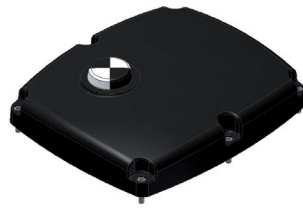

Body (upper part)

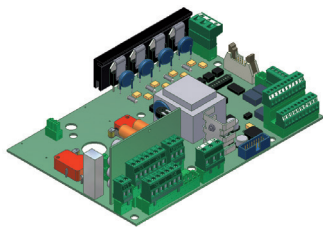
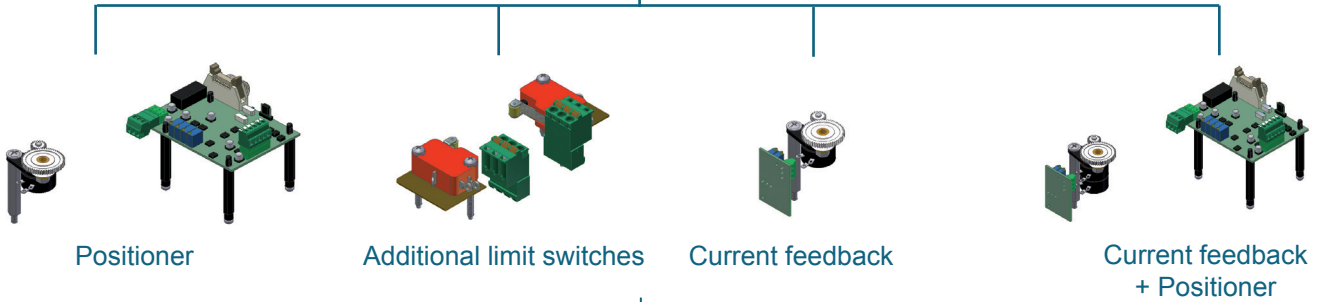

Main board three phase AC

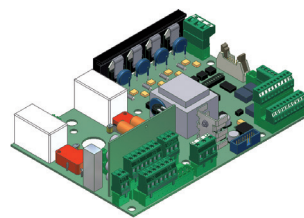

Main board AC

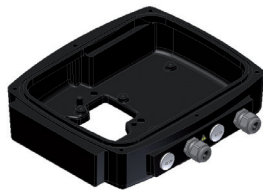

Body (lower part)

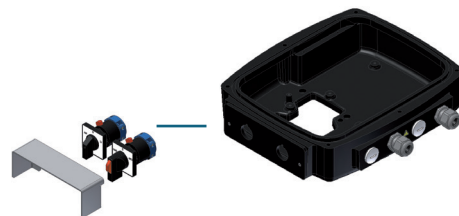

Body (lower part) with local control



E 65



E 110



E 160



E 210

ORDER CODES

Order Code		Standard			Options			
		Main Board PI.E71-Local	Digital remote control inputs	Digital feedback	Additional Limit Switches	Current Feedback 4-20mA	Local control	Positioner PI.E71-POS
Alternating Current	Three-Phase Current							
M71-WS-001-40	M71-DS-001-40	X	X	X				
M71-WS-002-40	M71-DS-002-40	X	X	X	X			
M71-WS-003-40	M71-DS-003-40	X	X	X		X		
M71-WS-004-40	M71-DS-004-40	X	X	X			X	
M71-WS-005-40	M71-DS-005-40	X	X	X	X	X		
M71-WS-006-40	M71-DS-006-40	X	X	X		X	X	
M71-WS-007-40	M71-DS-007-40	X	X	X	X		X	
M71-WS-008-40	M71-DS-008-40	X	X	X	X	X	X	
M71-WS-009-40	M71-DS-009-40	X		X				X*
M71-WS-010-40	M71-DS-010-40	X		X	X			X*
M71-WS-011-40	M71-DS-011-40	X		X		X		X*
M71-WS-012-40	M71-DS-012-40	X		X			X	X*
M71-WS-013-40	M71-DS-013-40	X		X	X	X		X*
M71-WS-014-40	M71-DS-014-40	X		X		X	X	X*
M71-WS-015-40	M71-DS-015-40	X		X	X		X	X*
M71-WS-016-40	M71-DS-016-40	X		X	X	X	X	X*

* If a positioner is installed, remote control information is disconnected

Actuators with fail-safe position OPEN/CLOSE

Direct Current				
M71-GS-100-40	PI.E71-GS		X	without additional power charge unit for battery pack
M71-GS-200-40	PI.E71-GS		X	with additional power charge unit for battery pack



This version provides a safety position in case of power loss.