

Centric, lined butterfly valves Series Z, F, M, T, TW, BE

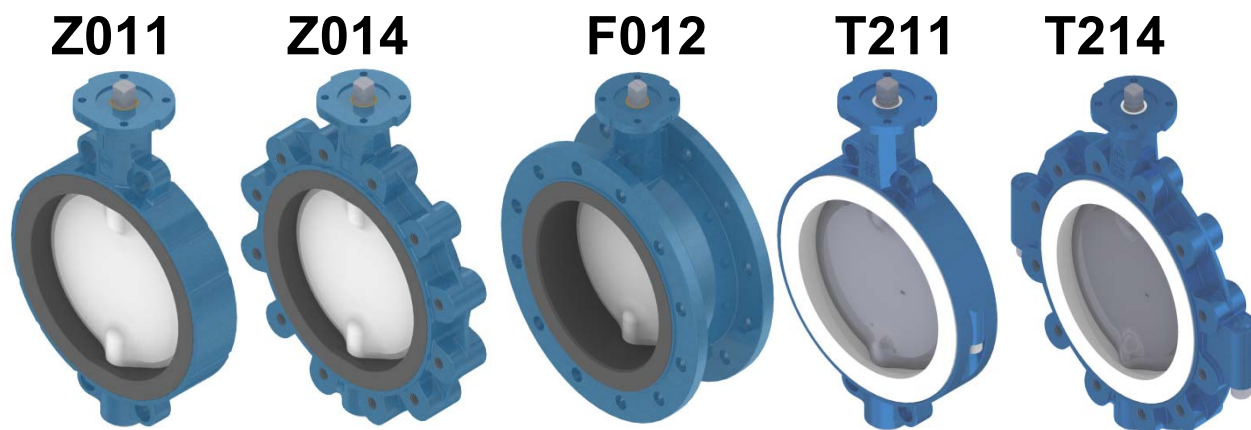

Examples shown above, not all possible type variants are shown!

Operating Instructions with technical Appendix

**in accordance with EG-Machine Directive 2006/42/EG
in accordance with EG-Pressure Equipment Directive
97/23/EG**

English version

Contents

	page
<u>A) GENERAL</u>	<u>3</u>
A1 EXPLANATION OF SYMBOLS	3
A2 INTENDED USE	3
A3 BUTTERFLY VALVE LABELLING	4
A4 TRANSPORT AND STORAGE	4
<u>B) FITTING THE VALVE INTO THE PIPE SYSTEM / PRESSURE TESTING</u>	<u>5</u>
B1 SAFETY ADVICE FOR FITTING OF VALVES	5
B2 REQUIREMENTS FOR FITTING INTO THE PIPE SYSTEM	5
B3 FITTING PROCESS	6
B4 PRESSURE TESTING BEFORE/DURING OPERATION	7
B5 SUPPLEMENTARY INFO: DISMANTLING THE VALVE	8
<u>C) OPERATING MANUAL</u>	<u>9</u>
C1 SAFETY INSTRUCTIONS FOR OPERATION AND MAINTENANCE	9
C2 MANUAL OPERATION/AUTOMATIC OPERATION	9
C3 TROUBLESHOOTING	10
<u>D) TECHNICAL APPENDIX / PLANNING DOCUMENTATION</u>	<u>11</u>
D1 TECHNICAL SPECIFICATION OF THE VALVE	11
D2 P/T-RATINGS	11
D3 DRAWING / BILL OF MATERIALS	13
D4 REPLACEMENT PARTS	13
D5 FLANGE BOLTS FOR CENTRIC VALVES	13
<u>DECLARATION IN COMPLIANCE WITH EU-DIRECTIVES</u>	<u>14</u>

More information and current addresses of our branch offices and resellers can be found under:



www.ebro-armaturen.com

EBRO ARMATUREN GmbH
Karlstraße 8
D-58135 Hagen
☎ (02331) 904-0
Fax (02331) 904-111

A) General

A1 Explanation of Symbols

Notes in these instructions are indicated by symbols:

 XXXXX	Hazard / Caution / Warning ... draws attention to a dangerous situation which may cause death or serious injuries to people and/or damage to the piping system.
	Attention ... draws attention to an imperative instruction.
	Information ... provides useful tips and recommendations.

If these notes, cautions and warnings are not followed, hazards may result and the manufacturer's guarantee may become void.

A2 Intended Use

After fitting between flanges of a piping system, butterfly valves belonging to **Series Z, F, M, T, TW and BE** are designed to shut off and convey media within the maximum pressure and temperature tolerances or to regulate its flow.

The maximum pressure and temperature tolerances (dependent on the housing/lining materials) are indicated in the name plate of the valve by **TS** and **PS** (see section A3).

The valve may only be operated after reference to the following documents:

- <Declaration according to EU Directives> – see above
- This assembly/operating manual which is supplied with the valve.

The valve may only be used in ☒-hazardous environments , if

▶ the purchaser has made explicit reference to this.

Non-compliance with this <intended use> constitutes an act of gross negligence and releases EBRO-Armaturen from any product liability.

A3 Butterfly valve Labelling

Each butterfly valve carries the following information on the housing or on the name plate:

for	Code	Remarks
Manufacturer	EBRO-ARMATUREN	Address see page 2 <Content>
Valve type	e.g. Z011	(Housing model) see overview page 1
Conformity	CE	Conformance with Pressure Equipment Directive 97/23EG
ID Number	0036	„Notified body according to EU-Directive = TÜV Süddeutschl.
SN (Factory-Nr.)	e. g. 123456/012/001 *	Numbers 1-6: EBRO-Com.Nr, Numbers 7-9: Order position Numbers 10-12: serial nr. of an order position
DN	DN (and figure)	(Housing model) e.g. DN80
PN	e.g. PN 16	The required PN-level of the counter flange
Temp.limits	TS (and figure)	Figures for upper and lower operating limits
Maximum pressure tolerance	PS (and figure)	Figures in bars (at Room temperature)
Material	e.g.: EN-JS 1030	(Housing code) Housing material
	e.g.: 1.4408	(in the name plate) Material of butterfly valve disc
	e.g.: 1.4104	(in the name plate) Material of shaft
	e.g.: NBR	(in the name plate) Material of lining

**) Note: The year of manufacture is encoded in the factory nr.*

The name plate should not be covered, in order that the fitted valve remains identifiable.

A4 Transport and storage

To transport correctly:

- Leave the Valve in the factory packaging until use (assembly).
- Store the valve in a secure area and protect against dirt and damp.
- Attach lifting straps as in fig 1 to fig 3.

!	<p>Do not suspend large valves on gear or drive mechanisms! Protect valve discs and flange mating surfaces against possible damage</p>
----------	---

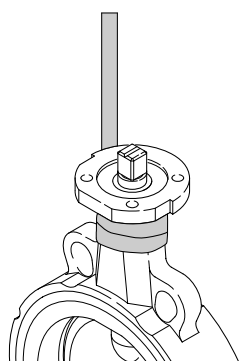

Fig1

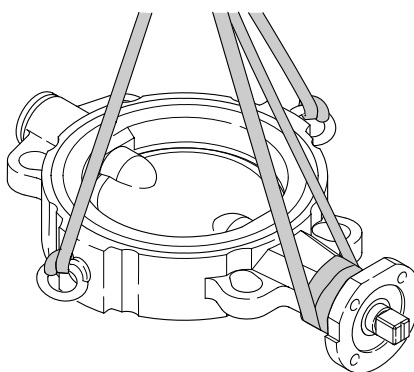

Fig 2

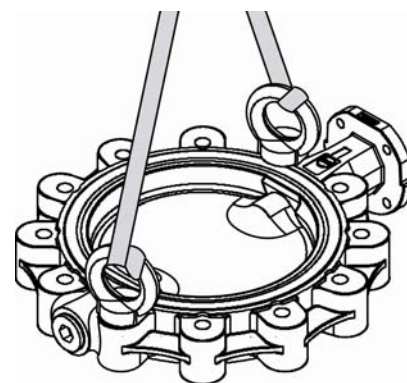

Fig 3

!	<p>Valves which are supplied without an actuator: The butterfly valve disc is not secured against displacement. The disc must be transported in such a way that it cannot be opened from its transport position through outside factors (e.g. vibrations).</p>
----------	---

B) Fitting the valve into the pipe system / Pressure testing



This instruction includes safety advice relating to foreseeable risks when fitting the valve into a pipe system.
It is the responsibility of the user to follow this advice with regard to other risks, in particular those relating to local conditions. All preconditions for the system should already be in place.

B1 Safety advice for fitting of valves



- Valves may only be fitted into the system by qualified persons. „Qualified“ in the context of this manual means persons who can correctly assess and carry out the tasks assigned to them and can recognise and eliminate any risk on the basis of their training, specialist knowledge and professional experience.
- The intended function of a valve after fitting must correspond to the <intended use> described in Section A2.
- Pressure may not be applied to a valve which is not locked into a (any) position on actuation.
- An actuator fitted onto a valve may only be actuated if the valve is surrounded on both sides by the pipe or valve section – any actuation before this point constitutes a crush hazard and is solely the responsibility of the user.
- A valve which closes a pipe section as an <end fitting> under pressure from within the pipe, must be secured with a blank flange in such a way that no leaks can occur.

B2 Requirements for fitting into the pipe system

- Ensure that only butterfly valves whose pressure classification and materials correspond to the operating conditions are fitted. See corresponding information on the name plate (*Section A3*)
- Normally the butterfly valve must be either adjusted with the hand lever/geared hand wheel or fitted with an actuator and adjusted ready for operation.
A valve will only be supplied without an actuator in special cases for retrofitting purposes
- The butterfly valve should be left in the factory packaging for storage and transport and only unpacked immediately before fitting into the pipe section.



Caution

The outer edge of the disc is very finely machined, in order to ensure that a (closed) butterfly valve is sealed. Please ensure that this surface is not damaged when handling during fitting.

- Flanged valves must be fitted on or between flanges according to EN 1092-1 or EN 1759-1, with mating surfaces according to form A or B which must be machined plane-parallel and must be aligned. The use of other flanges and/or other forms of sealing faces must have been verified in the order confirmation from EBRO Armaturen.
- The clearance of the counter flange must leave sufficient space for the butterfly valve disc when opening, so that the disc is not damaged when opening out, thus becoming unusable.
See Table. *Dimensions may vary depending on type*

**OPERATING MANUAL FOR CENTRIC BUTTERFLY VALVES
SERIES Z, F, M, T, TW, BE**

	<i>Minimum required inner diameter D_i of the counter flange</i>														
	DN	50	65	80	100	125	150	200	250	300	350	400	450	500	600
	Ø D_i	51	51	80	103	124	151	196	245	296	334	385	438	484	560

- All interior surfaces of the valve must be free of dirt – especially hard/sharp particles. The pipe sections on both sides must be also be clean: Follow the advice in Section B3 to flush out a pipe with a fitted valve.

	If dirt (Welding beads, rust particles etc.) is not removed, the mating surface on the butterfly valve disc may be damaged: The valve may leak, and at worst will become unusable.
---	--

- The butterfly valve is supplied (almost) closed and must also be fitted as such, in order to protect the mating surface on the disc against damage.
- The ends of the pipes must be aligned and have plane-parallel joint planes.

	<p>Flange seals must not be used for centric valves</p> <p>The use of additional flange seals is normally not necessary. The mating surfaces on the butterfly valve housing are lined with elastomer or polymer and are designed for sealing the flange joint.</p> <p>To seal the joint, the counter flanges must be smooth and have full-faced mating surfaces, e.g. Form A or B, in line with Standard EN 1092-1 or EN 1759-1.</p> <p>Other types of flange must be used only with the agreement of the manufacturer.</p>
---	--

B3 Fitting process

	The lining in the housing must not come into contact with grease, in particular with mineral oil based grease or lubricant.
---	---

- Inspect Valve and actuator for transport damage. Damaged butterfly valves or actuators may not be fitted.
- The preferred assembly position of the valve is with a horizontal shaft. The gear mechanism should – if possible – not be housed directly below the valve: Leaks on the shaft may damage the gear mechanism or actuator.
- Butterfly valves for fitting between flanges must be carefully centred when fitting with flange bolts. **Follow the advice on flange bolts in Section D5 !**
- If a valve is supplied without an actuator device in special cases, it must be fitted closed and left like this until the actuator is retrofitted. An assembly instruction for this must be supplied by the actuator manufacturer. The nominal torque must be adjusted to match the valve and the end stops „OPEN“ and „CLOSED“ must be set correctly.

	Ensure that pressure is not applied to a butterfly valve like this before the actuator is fitted.
Warning	

- Butterfly valves can be fitted irrespective of the direction of flow of the medium.

	<p><i>Valve with pneumatic <fail safe> actuator (with opening spring):</i> A <fail safe> actuator with opening spring must be closed by means of a compressed air connection (or alternative) for insertion between the counter flanges. The assembly instruction of the actuator must be followed and it must be ensured that the butterfly disc is not suddenly opened accidentally (risk of injury!).</p>
---	--



- After fitting, the butterfly valve disc should be opened to flush the pipe, to ensure that the pipe section is clean before the valve is closed the first time.

	<p>Before closing the first time, hard/abrasive dirt (welding beads, rust particles etc.) must be removed from the pipe section.</p>
---	--

- *When fitting onto the end of a pipe section:*

 Danger!	<p>If the butterfly valve is mounted as an end fitting and pressure is applied, it must be sealed with a blank flange, in order to prevent damage to people or property through leaks or to prevent accidental opening.</p>
---	---

- To connect an actuator to the machine controller, follow the relevant manufacturers instructions.

	<p><i>A gear mechanism or actuator is adjusted to match the operating data included in the order:</i> The setting on the „CLOSED“ end stop of a brand new valve should not be changed as long as the valve is sealed when closed.</p>
 Note	<p><i>Only for butterfly valves with electrical actuators</i> Ensure that the actuator is switched off in the end settings by the microswitch signal, The torque switch signal should be used for a fault indicator. The fault should be rectified as quickly as possible, see section C3 <Troubleshooting>. <i>For more advice refer to the Electrical actuator manual.</i></p>

- To complete the fitting, a function test must be carried out: Using the lever or hand wheel, a butterfly valve should be actuated by hand as quickly as possible to the full opening angle. An actuator fitted on the butterfly valve must be moved smoothly into the <OPEN> or <CLOSED> positions using the control data indicated and following the control commands.
- Incorrectly executed control commands may cause a hazard and may damage the pipe system.

Any functional faults found must be rectified immediately before full operation. See also Section C3 <Troubleshooting>

B4 Pressure testing before/during operation

All butterfly valves have undergone a final inspection by the manufacturer ex factory in accordance with EN12266-1.



The test conditions for the pipe section apply when pressure testing a valve in the system – with the following provisos:

- The test pressure of a valve may not exceed **1.5x PS** (according to the name plate of the valve). **The butterfly valve disc must also be open at this test pressure.**
- If **pressure exceeding 1.1x PS is applied to a closed butterfly valve**, there is a risk of the interior sections of the valve being overstressed. This must be avoided at all costs.

B5 Supplementary Info: Dismantling the valve

Follow the same safety rules as for the (pipe) system and valve (see section B1).

- Check whether the pipe is disconnected, empty and at normal pressure.
- Fully close the valve, remove the flange bolts. Prise apart the flange with a tool.
- Remove the valve (do not damage the flange mating surface when removing the valve) and store away in a well-protected place. Protect the mating surfaces.
- Refer to Section A4 for attaching lifting straps.

 Danger	<i>If a fitting is dismantled from pipes containing dangerous substances and needs to be removed from the system: The sections of the valve which come into contact with the product (disc, shaft and seat ring) must be properly decontaminated before repair.</i>
	<i>After dismantling the valve: The housing lining must not come into contact with grease, in particular mineral oil based grease or lubricant.</i>



C) Operating Manual

Under the provisions of MRL 2006/42/EG, the system planner must conduct a full risk analysis. For this purpose, EBRO-Armaturen provide the following documentation:

- This assembly and operating manual,
- The attached Declaration of EU Directives.

	<p><i>This manual contains safety instructions for foreseeable risks when using the valve for industrial applications.</i></p> <p>The planner /operator is responsible for supplementing these instructions for other risks specific to the machinery used.</p>
---	---

C1 Safety instructions for operation and maintenance

  Danger	<ul style="list-style-type: none"> • The function of a valve must match the <Intended Use> described in Section A2. • The operating conditions must correspond to the information on the name plate of the butterfly valve. • Any required work on the valve may only be carried out by qualified persons. „Qualified“ in the context of this manual means persons who can correctly assess and carry out the tasks assigned to them and can recognise and eliminate any risk on the basis of their training, specialist knowledge and professional experience. • Before loosening a lock screw or screw on the housing cover or before dismantling the entire valve from the pipe system, the pressure in the system or pipe section must be reduced on both sides of the valve, so that the medium does not escape uncontrolled from the pipe.
 Crush hazard	<ul style="list-style-type: none"> • An actuator fitted onto a valve may only be actuated if the valve is surrounded on both sides by the pipe or valve section – any actuation before this point constitutes a crush hazard and is solely the responsibility of the user.

C2 Manual operation/automatic operation

The valve closes in a clockwise direction when actuated and opens in an anti-clockwise direction.

A butterfly valve with manual actuation only requires normal manual force to actuate it, do not use any extensions to the hand wheel ("Valve wheel hook" or similar tool)!

A butterfly valve with actuator must be actuated by the controller signals. Butterfly valves which have been supplied with an actuator ex factory, are set precisely ex factory – this setting in the gear mechanism/actuator should not be reset as long as the valve works properly.

The only maintenance required is a visual inspection at appropriate intervals of the tightness of the flange connection for media leaving the valve – if any leakage occurs see Section C3 <Troubleshooting>.

We recommend that you actuate butterfly valves which remain permanently in one position at regular intervals, in order to ensure continued free movement.

C3 Troubleshooting

Type of problem	Actions
Leaking from the flange connection to the pipe system	<p>Seal the flange connection between the housing and pipe system: Follow instructions in the Operating manual for the pipe system and the installation instructions (see Section D5) for the corresponding fitting.</p> <p><i>If the leak cannot be stopped by retightening the flanges:</i> Ensure that the pipe flanges are aligned and plane-parallel – and /or change the lining of the housing. Follow Section B1 <Safety instructions...>, and request replacement parts and the necessary manual from EBRO-Armaturen.</p>
Leaking from the shaft seal	<p><i>If the shaft seal is not tight:</i> Repair needed: Replace shaft seal. Follow instructions from sections B1 and C1 <Safety instructions...> and request replacement parts and the necessary manual from EBRO-Armaturen.</p>
Leak in the passage seal (disc / sleeve seal)	<p>Check whether the valve is 100% closed with full actuation torque.</p> <p><i>If the valve is still not tight when closed:</i> Open/close valve several times under pressure.</p> <p><i>If the valve is still not tight:</i> Repair needed: Replace Housing lining (sleeve). Follow instructions from section C1 <Safety instructions...> and request replacement parts and the necessary manual from EBRO-Armaturen.</p>
Functional problems	<p>Dismantle valve (follow instructions from sections B1 and C1 <Safety instructions...>) and inspect.</p> <p><i>If the valve is damaged:</i> Repair needed: request replacement parts and the necessary manual from EBRO-Armaturen</p>

D) Technical Appendix / Planning documentation

Note:

This appendix is not an integral part of the assembly and operating manual and is only an extract of the catalogue pages of EBRO-Armaturen for this valve type – for the full catalogue refer to the addresses in the table of contents.

D1 Technical Specification of the valve

The butterfly valve type <centric> conforms to Design Standard:

► **EN 593: Butterfly valves with housing made from metallic materials**

D2 p/t-Ratings

Dependent on <PS> and the housing and lining materials, the following maximum operating pressures are allowed dependent on the operating temperature:

Note: The figures may vary depending on type and material, for maximum pressure and temperature limits see section A2 and A3. Not all types and sizes are listed, p/t-ratings for versions not shown can be obtained on request.

PRESSURE/TEMPERATURE DIAGRAM

for valves with silicone elastomer inserts

Type T211-A

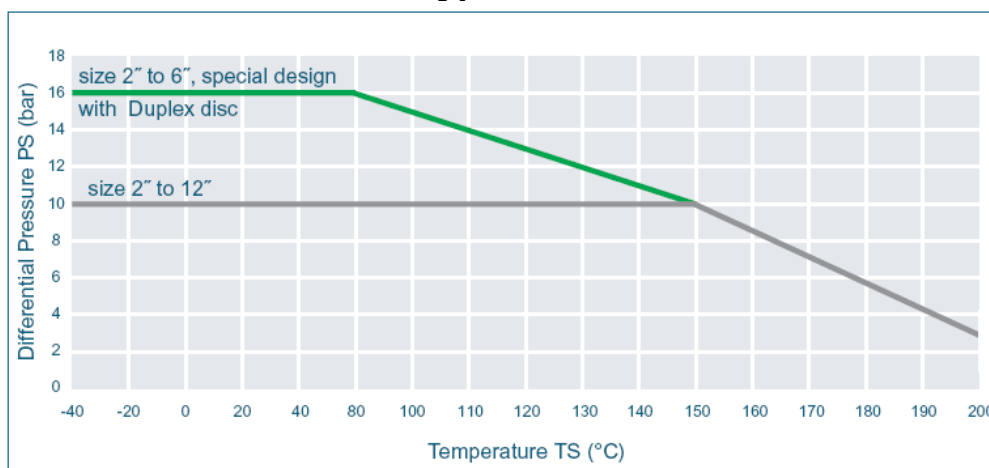

Vacuum service to 1 mbar, from -10 °C up to 160 °C

Type T212-A

PRESSURE/TEMPERATURE DIAGRAM

for valves with silicone elastomer inserts

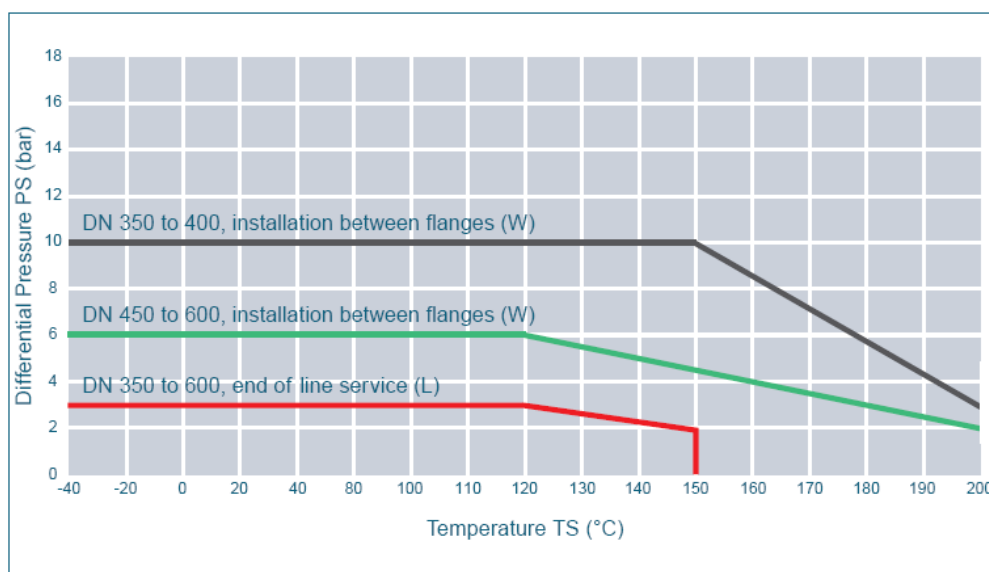

Typ T214-A

PRESSURE/TEMPERATURE DIAGRAM

for valves with silicone elastomer inserts

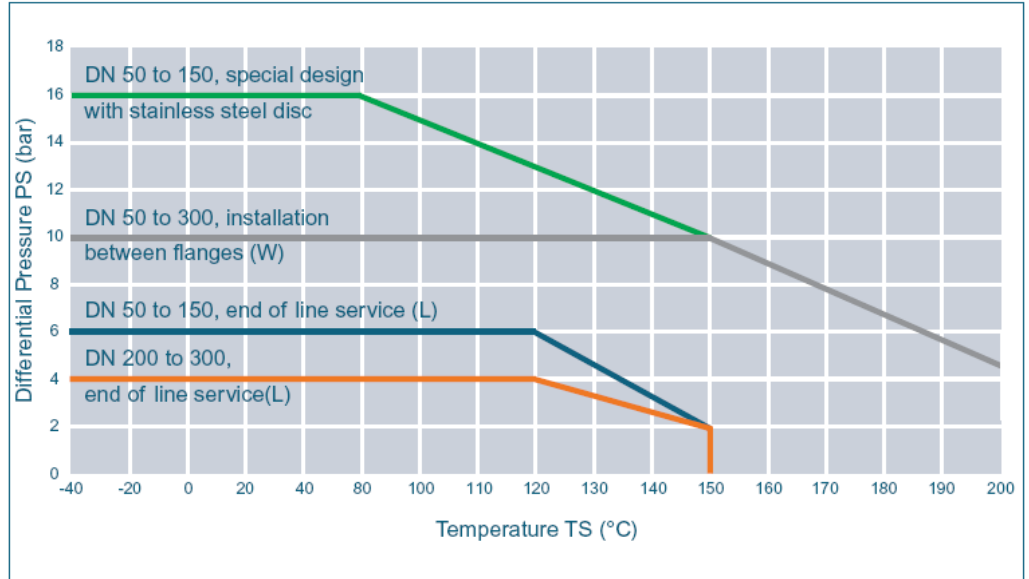

Vacuum service to 1mbar, from -10°C up to 160°C

Type T200-C

**PTFE-Chemical valve T200-C
with Silicon Elastomer lining**

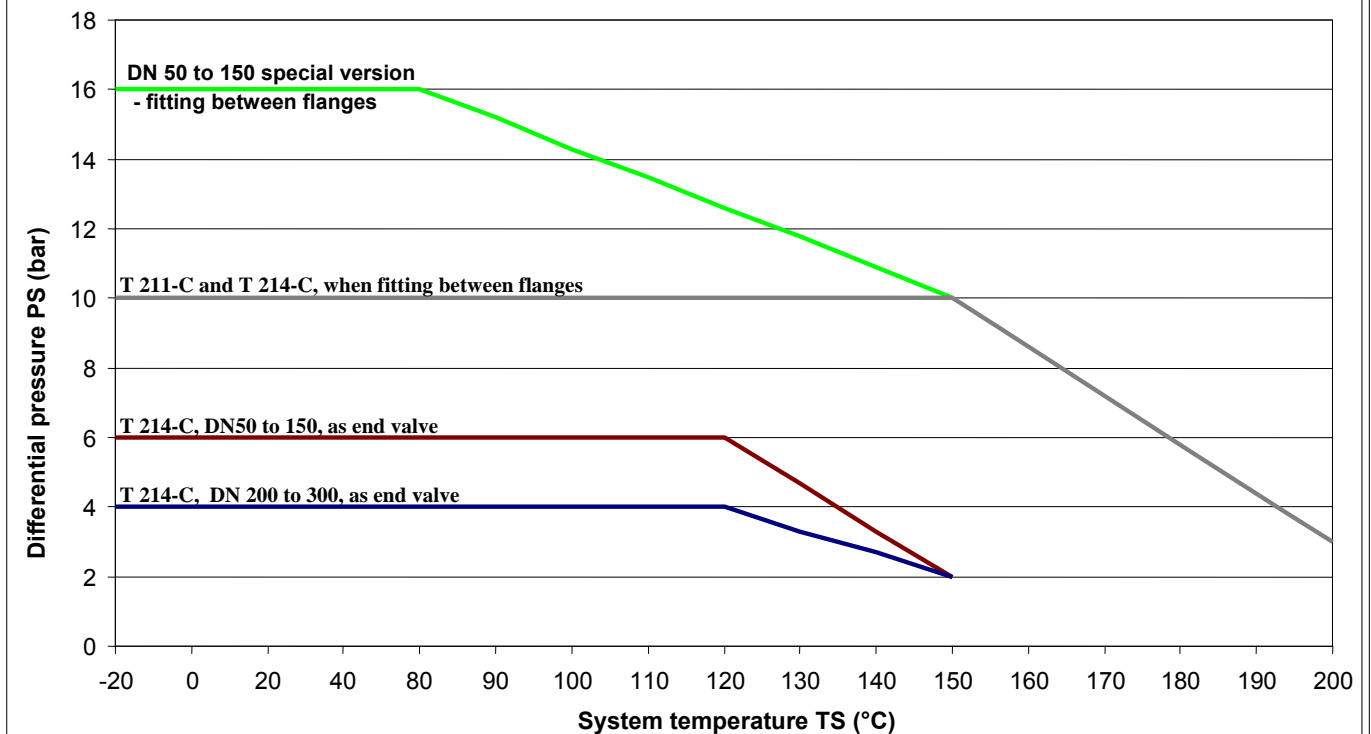

PRESSURE-TEMPERATURE-DIAGRAM Type Z011-A / Z014-A DN50-DN300
for versions with EPDM-sleeve EBRO-Standard „black“

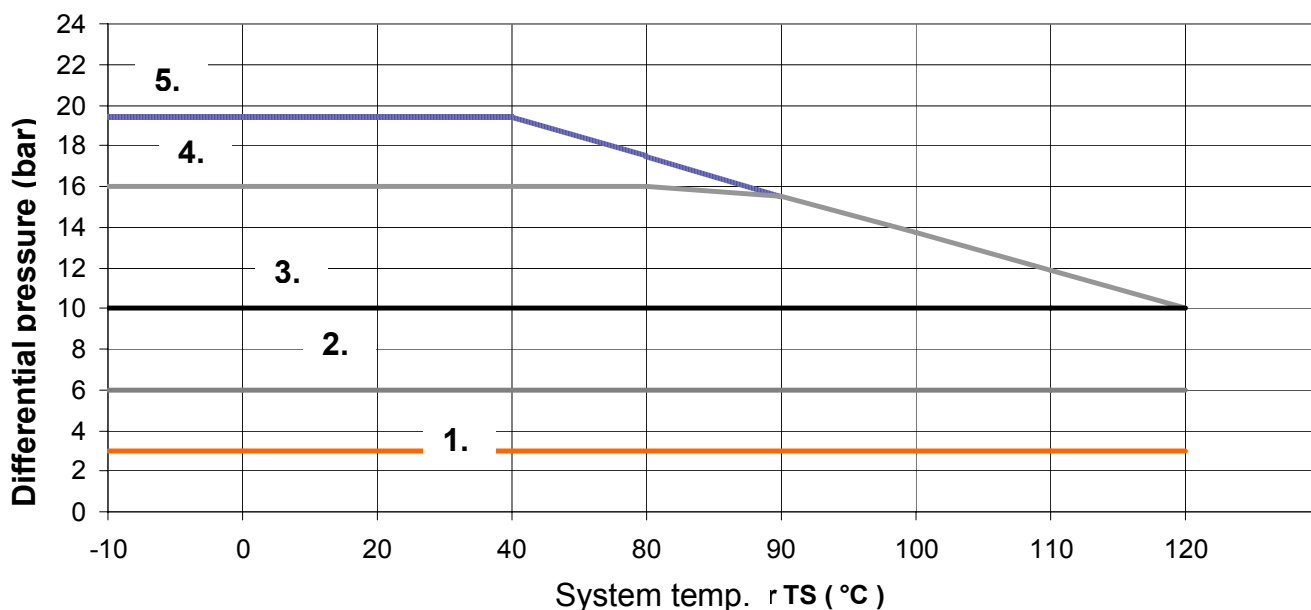

	Pressure rating of disc (bar)	PS (bar) Z011-A / Z014-A between flanges
1.	3	3
2.	6	6
3.	10	10
4.	16	16
5.	19,2 (full rating pressure)	16

D3 Drawing / bill of materials

The drawings assigned to the valves and standard bills of materials can be downloaded from the EBRO- „Download menu“.

www.ebro-armaturen.com/doku

D4 Replacement parts

In the bill of materials in the datasheets described under section **D3**, the replacement parts are highlighted by the note „(empfohlenes Ersatzteil / recommended spare part)“. Only EBRO-Original parts can be fitted. Request replacement parts and the necessary manual from EBRO-Armaturen.

D5 Flange bolts for centric valves

The flange bolts compatible with the valve and relevant assembly instructions can be found in the EBRO ARMATUREN-Company standard sheets EW1806 to EW1810 and EW1830 ff. This can be downloaded from the „Download menu“ (Address see Page 4 or Link below).

www.ebro-armaturen.com/doku

Declaration in compliance with EU-Directives

The manufacturer

EBRO Armaturen
Gebr. Bröer GmbH
Karlstrasse 8
58135 Hagen
Deutschland

declares that the valves

EBRO-butterfly valves in centric and excentric design
Series Z, F, M, T, TW, BE and Series HP

Are manufactured in accordance with the requirements of the following standards:

EN 593 **Product Standard Butterfly valves with metal housing**
prEN 12100:2009 **Safety of machines – Basic terms, general design guidelines**

Product documents are available on the following:

Planning documentation, Technical datasheets, catalogue pages

These products comply with the following directives:

Pressure Equipment Directive 97/23 EG (DGRL) [applies if Art 3 Paragraph 1.3 or Art. 3 Paragraph 3 is applicable]

The valves comply with this directive. The conformity rating procedure used according to Annex III of the Pressure Equipment Directive 97/23 EG is

-	For Category I	Module A
-	For Category II and III	Module H
-	For Category IV	Module B + D

Name of notified body: TÜV Süd Industrie Service GmbH Reg-Nr. 0036

Machine Directive 2006/42 EG (MRL) [applies if the valve is not actuated manually]

1. The products are a „partly completed machine“ under the terms of Art 2 g) of this Directive
2. The table overleaf lists whether and how the requirements of this Directive are met
3. This declaration is the Declaration of Incorporation under the terms of this Directive

To comply with the directive above, the following applies:

1. The user must comply with the <intended use> , defined in the „Original Assembly and Operating Manual“ (BA 1.0-DGRL/MRL or BA 3.0-DGRL/MRL) supplied with the valve and must follow all instructions in this manual. If this manual is not followed, the manufacturer may – in serious cases – be released from his product liability.
2. The valve must not be put into operation (and the fitted actuator if applicable) until the conformity to all applicable EU directives above of the system into which the valve is fitted has been declared by the persons responsible. A separate declaration is supplied for the actuator named above.
3. EBRO-Armaturen has conducted and documented the required risk analyses, the EBRO Armaturen employee responsible for this documentation is Bernhard Mitschke.

Hagen, 4.12.2009

Dirk Mischnick, Managing Director

**OPERATING MANUAL FOR CENTRIC BUTTERFLY VALVES
SERIES Z, F, M, T, TW, BE**

The manufacturer	EBRO ARMATUREN Gebr. Bröer GmbH, D58135 Hagen
declares that the valve fitting EBRO-Butterfly valve in centric and excentric design complies with the following provisions:	
Requirement according to Annex I of the Machine Directive 2006/42/EG	
1.1.1. g) Intended use	see Assembly, Operating manual
1.1.2..c) Warnings against incorrect use	see Assembly, Operating manual
1.1.2..c) Required protective equipment	Exactly as per the pipe section into which the valve is fitted
1.1.2..e) Accessories	No special tool required for changing consumable parts
1.1.3 Parts in contact with media	All materials coming into contact with media are specified in the type datasheet and in the order confirmation. The user is required to conduct an appropriate risk analysis.
1.1.5 Handling	Met through the instructions in the Assembly, Operating manual
1.2 and 6.2.11 Control	Responsibility of the user in accordance with the Assembly Manual of the actuator
1.3.2 Preventing risk of breakage	For pressure retaining parts of the valve: Certified through Declaration of Conformity with DGRL 97/23 EG. For functional parts: Guaranteed through intended use of actuator
1.3.4 Sharp corners and edges	Requirement met
1.3.7/8 Risk of injury through moved parts	Requirement met through intended use Maintenance and repair only when valve/actuator is not in operation
1.5.1 – 1.5.3 Power supply	Responsibility of user See also Assembly manual of actuator
1.5.5 Permitted temperature exceeded	see Warnings in Assembly, Operating Manual, Section <Intended Use>
1.5.7 -Explosion	 -protection required. Must be stated explicitly in Purchase Contract. In this case: Only use as directed on the valve
1.5.13 Emission of hazardous substances	Not applicable
1.6.1 Maintenance	see Operating manual. Discuss keeping stock of consumables with EBRO-Armaturen.
1.7.3 Labelling	Valve: According to assembly manual. Actuator: According to assembly manual.
1.7.4 Operating Manual	Any supplementary information required for the full manual of the <completed machine> are summarised in the Operating Manual document see Section C of the Assembly, Operating manual
Requirements according to Annex III	The valve is not a <complete machine>: No CE Mark for conformance to the MRL
Requirements according to Annex III and Annex VIII-XI	Not applicable
Requirement according to prEN 12100:2009	
1. Scope	The risk analysis for the valve/actuator is conducted from the perspective of a <partly completed machine>. The analysis has been based upon Product Standard EN593:<Butterfly valve with metal housing > with an actuator according to EN15714-2 or EN15714-3 , Class A . This is also based on industrial application and on average >20-years experience in using the above valve types. This has resulted in the instructions and warnings in the above assembly manual and operating manual. <i>Note:</i> <i>It is a prerequisite that the user conduct a risk analysis tailored to the application for the pipe section including the valves used, in accordance with Sections 4 to 6 of EN 12100 – this cannot be done for EBRO Armaturen for standard valves.</i>
3.20, 6.1 inherently safe design	The butterfly valves are designed according to the principle of <inherently safe design>. The <intended use> is a prerequisite.
Analysis according to 4, 5 and 6	Based on knowledge of malfunctions recorded by the manufacturer and misuse within the context of a claim for damages (Documentation according to ISO9001).
5.3 Machine limits	The limits of the partly completed machine have been set according to the <intended use> of the valve as well as of the actuator
5.4 Decommissioning, disposal	Not within the responsibility of the manufacturer
6.2.2 Geometric Factors	Since the valve and the actuator enclose the function parts if used as intended, this section does not apply.
6.3 Technical protection equipment	Only required for special actuators – see order confirmation
6.4.5 Operating manual	Since valves with an actuator work „automatically“ according to the commands of the controller, those aspects which are <typical to the valve> are described in the operating manual and must be made available to the manufacturer of the pipe system
7 Risk analysis	The conducted risk analysis has been carried out according to Annex VII, B) by EBRO-Armaturen and is documented according to MRL Annex VII B).