

Block and Bleed Valves Series Q

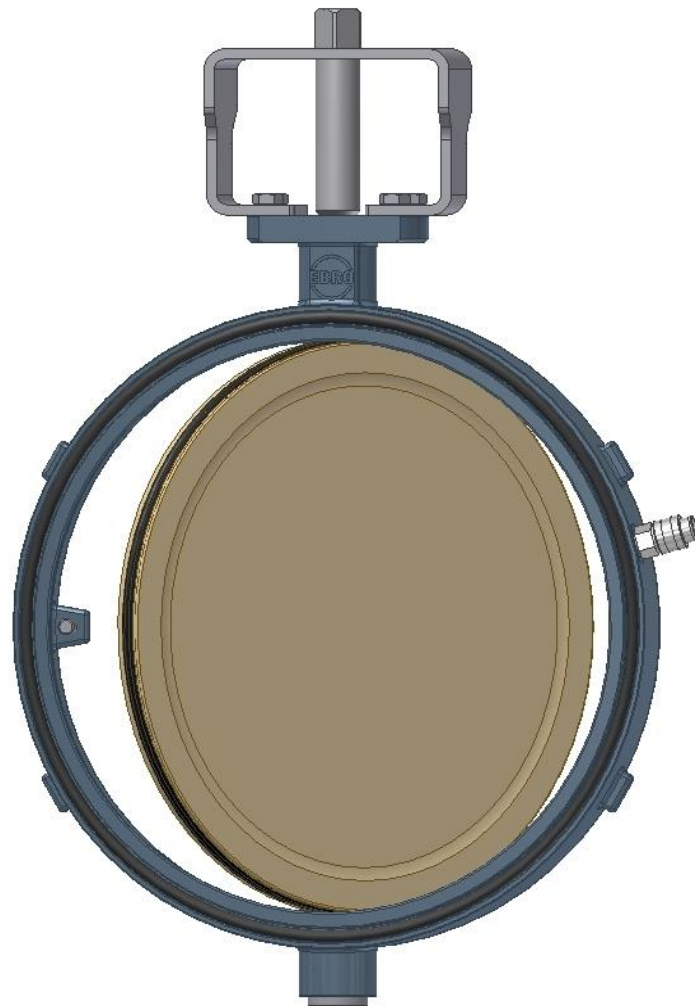

Sample Picture, does not show all options!

Operating instructions and technical addenda

According EC machinery directive 2006/42/EG

Language English

Content

	Seite
A) GENERAL	3
A1 EXPLANATION OF SYMBOLS	3
A2 INTENDED USE	3
A4 TRANSPORTATION AND STORAGE	4
B) FITTING THE VALVE INTO THE PIPE SYSTEM / PRESSURE TESTING	4
B1 SAFETY INSTRUCTIONS FOR INSTALLATION	4
B2 REQUIREMENTS FOR FITTING INTO THE PIPE SYSTEM	5
B3 FITTING PROCESS	5
B4 PRESSURE TESTING BEFORE/DURING OPERATION	6
B5 SUPPLEMENTARY INFO: DISMANTLING THE VALVE	6
C) OPERATING MANUAL	7
C1 SAFETY INSTRUCTIONS FOR OPERATION AND MAINTENANCE	7
C2 BLOCK AND BLEED FUNCTION	8
C3 LUBRICATION INSTRUCTION	8
C4 MANUAL OPERATION / AUTOMATIC OPERATION	9
C5 TROUBLESHOOTING	9
D) TECHNICAL APPENDIX / PLANNING DOCUMENTATION	10
D1 TECHNICAL SPECIFICATION OF THE VALVE	10
D2 DRAWING / BILL OF MATERIALS	10
D3 SPARE PARTS	10
DECLARATION IN COMPLIANCE WITH EU-DIRECTIVES	11

More information and current addresses of our branch offices and resellers can be found under:





www.ebro-armaturen.com

EBRO ARMATUREN GmbH
 Karlstraße 8
 D-58135 Hagen
 ☎ (02331) 904-0
 Fax (02331) 904-111

A) General

A1 *Explanation of Symbols*

Notes in these instructions are indicated by symbols:

	Absolute Prohibitionmust follow
 XXXXX	Hazard / Caution / Warning ... draws attention to a dangerous situation which may cause death or serious injuries to people and/or damage to the piping system.
	Attention ... draws attention to an imperative instruction.
	Information ... provides useful tips and recommendations.

Not to pay attention to this instructions and warnings may result in dangerous situations and the manufacturer's liability could become invalid.

A2 *Intended Use*

Block and Bleed Valves Series Q are designated for building heating and ventilation facilities where some parts of the plant need to shut off gastight for safety reasons. The installation has to be between the flanges of the ventilation duct. The acceptable pressure load is 10000 Pascal. More operating data will be found in Section D1.

Before the valve is put into operation, the following documents require Attention:

- Declaration according EC directive
- This manual, which is supplied with the valve

The valve may only be used in -hazardous environments-, if

► the purchaser has made explicit reference to this.

Non-compliance with this <intended use> constitutes an act of gross negligence and releases EBROArmaturen from any product liability.

A3 *Marking*

The following data are marked on the body or name plate of every valve

	Designation	Remarks
Manufacturer		
Valve Type	e.g.: Q011	Marking on valve body
Fabrication-No.	e.g. 123456/012/001 *)	digit 1-6: Order-Number, digit 7-9: item digit 10-12: running number
Size	DN (and value)	Marking on valve body e.g. DN80
acceptable. Leakage	\hat{V}_L (and value)	values in [l/h] bei 20°C und 2500Pa differential pressure

*) **Note:** Year of fabrication is encoded into fabrication number.



The name plate may not covered thus the installed valve can be indentified at all time.

Other markings can be agreed between purchaser and manufacturer.

A4 Transportation and Storage

For appropriate transportation please consider the following topics:

- Leave the valve in its crate until use (assembly).
- Storage of the valve in closed buildings. Protect it from dust and moisture.
- Fixing the rope according picture 1 + 2.

	Don't fix large valves at the gear box or actuator! Protect the disk and the flange facings from any damaging.
	ISO 2230 provides detailed storage conditions for rubber equipped parts (complete valve or spare parts). It also provides allowable storage times.

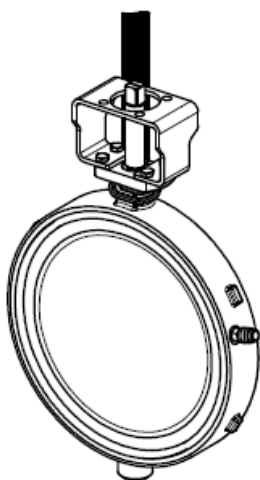

picture 1

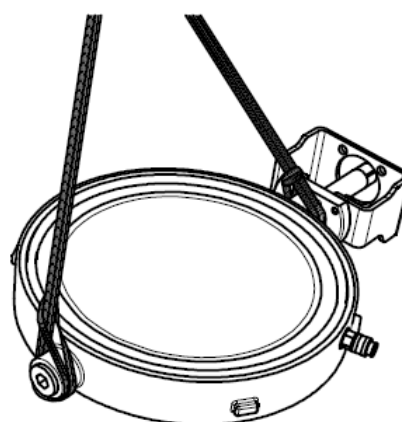



picture 2

	<i>Valves, delivered without actuator:</i> The disk isn't secured against rotation. Transportation has to be that way, the disk cannot move from closed position, when any action from outside (e.g. vibrations) applies.
-------------------------------------------------------------------------------------	------------------------------------------------------------------------------------------------------------------------------------------------------------------------------------------------------------------------------

B) Fitting the Valve into the Pipe System / Pressure Testing

	<i>This manual includes safety instructions for foreseeable risks while valve installation into a piping system.</i> It is the users responsibility, to complete the following advices for other, especially local conditioned risks. It is essential to follow all requirements.
-------------------------------------------------------------------------------------	--------------------------------------------------------------------------------------------------------------------------------------------------------------------------------------------------------------------------------------------------------------------------------------

B1 Safety Instructions for Installation

 	<ul style="list-style-type: none"> • Valve installation into the piping system has to be done by qualified personal. Qualified for the purpose of this manual are people, who, depending on their education, skills and experience, can evaluate correctly their assigned tasks and identify and remedy possible risks. • The considered function of the valve has to meet the < intended use > as written in section A2. • If the valve isn't locked with a hand lever or actuator in any position, it is not allowed to pressurize the valve. • Operation of an installed actuator is only allowed, when the valve is surrounded at both sides by piping or part of a vessel.– Any other actuation condition means danger of crushing and is solely the operators responsibility
----------------------------------------------------------------------------------------------------------------------------------------------------------------------------	------------------------------------------------------------------------------------------------------------------------------------------------------------------------------------------------------------------------------------------------------------------------------------------------------------------------------------------------------------------------------------------------------------------------------------------------------------------------------------------------------------------------------------------------------------------------------------------------------------------------------------------------------------------------------------------------------------------------------------------------------------------------------------------------------------------------------------

B2 Requirements for fitting into the pipe system

- Normally the butterfly valve must be either adjusted with the hand lever/geared hand wheel or fitted with an actuator and adjusted ready for operation. A valve will only be supplied without an actuator in special cases for retrofitting purposes.
- The butterfly valve should be left in the factory packaging for storage and transport and only unpacked immediately before fitting into the pipe section.

 Caution	The inside surface of the valve body is machined very precise and smooth to provide a good sealing function. Please be careful not to damage this surface during installation.
-----------------------------------------------------------------------------------------------------	--------------------------------------------------------------------------------------------------------------------------------------------------------------------------------

- The clearance of the counter flange must leave sufficient space for the butterfly valve disc when opening, so that the disc is not damaged when opening out, thus becoming unusable. See Table..

	<i>Minimum required inner diameter D_i of the counter flange</i>													
	DN			80	100	125	150	200	250	280	300	350	400	
Ø D_i			80	102	125	151	203	253	282	302	355	402		

- All interior surfaces of the valve must be free of dirt – especially hard/sharp particles. The pipe sections on both sides must be also be clean: Follow the advice in Section B3 to flush out a pipe with a fitted valve.

	If dirt (Welding beads, rust particles etc.) is not removed, the mating surface on the butterfly valve disc may be damaged: The valve may leak, and at worst will become unusable.
------------------------------------------------------------------------------------	------------------------------------------------------------------------------------------------------------------------------------------------------------------------------------

- The butterfly valve is supplied (almost) closed and must also be fitted as such, in order to protect the mating surface on the disc against damage.
- The ends of the pipes must be aligned and have plane-parallel joint planes.
- The valve must be installed free of piping loads.

	The required torque for flange bolting depends on displacement forces for the o-rings.
-------------------------------------------------------------------------------------	----------------------------------------------------------------------------------------

B3 Fitting process

- Inspect Valve and actuator for transport damage. Damaged butterfly valves or actuators may not be fitted.
- The preferred assembly position of the valve is with a horizontal shaft.
- Butterfly valves for fitting between flanges must be carefully centred when fitting with flange bolts. If not using the centering devices at the housing, any other methods (e.g. rings on flange bolts) may be used.
- If a valve is supplied without an actuator device in special cases, it must be fitted closed and left like this until the actuator is retrofitted. An assembly instruction for this must be supplied by the actuator manufacturer. The nominal torque must be adjusted to match the valve and the end stops „OPEN“ and „CLOSED“ must be set correctly.

 Warning	Ensure that pressure is not applied to a butterfly valve like this before the actuator is fitted.
-------------------------------------------------------------------------------------------------------	---------------------------------------------------------------------------------------------------

- Butterfly valves Series Q can be fitted irrespective of the direction of flow of the medium.

	Valve with pneumatic <fail safe> actuator (with opening spring): A <fail safe> actuator with opening spring must be closed by means of a compressed air connection (or alternative) for insertion between the counter flanges. The assembly instruction of the actuator must be followed and it must be ensured that the butterfly disc is not suddenly opened accidentally (risk of injury!).
-----------------------------------------------------------------------------------	----------------------------------------------------------------------------------------------------------------------------------------------------------------------------------------------------------------------------------------------------------------------------------------------------------------------------------------------------------------------------------------------------------------

- The pipe has to be clean.

	Before closing the first time, hard/abrasive dirt (welding beads, rust particles etc.) must be removed from the pipe section.
-----------------------------------------------------------------------------------	-------------------------------------------------------------------------------------------------------------------------------

- When fitting onto the end of a pipe section:

 Danger!	If the butterfly valve is mounted as an end fitting and pressure is applied, it must be sealed with a blank flange, in order to prevent damage to people or property through leaks or to prevent accidental opening.
-----------------------------------------------------------------------------------------------------	----------------------------------------------------------------------------------------------------------------------------------------------------------------------------------------------------------------------

- To connect an actuator to the machine controller, follow the relevant manufacturer's instructions.

	A gear mechanism or actuator is adjusted to match the operating data included in the order: The setting on the „CLOSED“ end stop of a brand new valve should not be changed as long as the valve is sealed when closed
-----------------------------------------------------------------------------------	----------------------------------------------------------------------------------------------------------------------------------------------------------------------------------------------------------------------------------

 Note	<i>Only for butterfly valves with electrical actuators</i> Ensure that the actuator is switched off in the end settings by the microswitch signal, The torque switch signal should be used for a fault indicator. The fault should be rectified as quickly as possible, see section C3 <Troubleshooting>. <i>For more advice refer to the Electrical actuator manual.</i>
---------------------------------------------------------------------------------------------------	---------------------------------------------------------------------------------------------------------------------------------------------------------------------------------------------------------------------------------------------------------------------------------------------------------------------------------------------------------------------------------

- To complete the assembly, a function test must be carried out: Using the lever or hand wheel, a butterfly valve should be actuated by hand as quickly as possible to the full opening angle. An actuator fitted on the butterfly valve must be moved smoothly into the <OPEN> or <CLOSED> positions using the control data indicated and following the control commands
- Incorrectly executed control commands may cause a hazard and may damage the pipe system. Any functional faults found must be rectified immediately before full operation. See also Section C3 <Troubleshooting>

B4 Pressure testing before/during operation

All butterfly valves have undergone a final inspection by the manufacturer ex factory.

The test conditions for the pipe section apply when pressure testing a valve in the system.

	Leakage test of packing: when leaking: Turn Adjustment screw at the packing in small steps until the leakage stops. Don't tighten more than necessary!
-------------------------------------------------------------------------------------	---------------------------------------------------------------------------------------------------------------------------------------------------------------------

B5 Supplementary Info: Dismantling the valve

Follow the same safety rules as for the (pipe) system and valve (see section B1).

- The valve has to be removed with closed disk from flange connection.
- For fixing the lifting ropes refer section A4.
- Do not damage the flange mating surface when removing the valve.

 Danger	<i>If a fitting is dismantled from pipes containing dangerous substances and needs to be removed from the system:</i> <i>The sections of the valve which come into contact with the product (disc, shaft and seat ring) must be properly decontaminated before repair.</i>
------------------------------------------------------------------------------------------------------	-------------------------------------------------------------------------------------------------------------------------------------------------------------------------------------------------------------------------------------------------------------------------------

C) Operating Manual

Under the provisions of MRL 2006/42/EG, the system planner must conduct a full risk analysis. For this purpose, the manufacturer provides the following documentation:

This assembly and operating manual,
The Declaration of EC Directives



This manual contains safety instructions for foreseeable risks when using the valve for industrial applications.

The planner/operator is responsible for supplementing these instructions for other risks specific to the machinery used

C1 **Safety instructions for operation and maintenance**



Danger

- The function of a valve must match the <Intended Use> described in Section A2.
- The operating conditions must correspond to the information on the name plate of the butterfly valve.
- Any required work on the valve may only be carried out by qualified persons. „Qualified“ in the context of this manual means persons who can correctly assess and carry out the tasks assigned to them and can recognise and eliminate any risk on the basis of their training, specialist knowledge and professional experience.
- The shaft is tightened by a PTFE Packing. Before loosening the screw of the packing, completely depressurize both valve sides thus no medium can pass the packing.
- For the first time the piping section comes under pressure, the tightness of the packing has to be checked.
If any Leakage:
Tighten the screw at the packing in small steps, until leakage stops. Don't tighten more than necessary.
- Before loosening a lock screw or screw on the housing cover or before dismantling the entire valve from the pipe system, the pressure in the system or pipe section must be reduced on both sides of the valve, so that the medium does not escape uncontrolled from the pipe.



Crush hazard

- An actuator fitted onto a valve may only be actuated if the valve is surrounded on both sides by the pipe or valve section – any actuation before this point constitutes a crush hazard and is solely the responsibility of the user.

C2 Block and Bleed Function

A special requirement for this valve is to check and monitor the valve tightness at any time. For this demand we have two sealing lines and control the spacing between these sealings. We can apply pressurized air or nitrogen in this spacing and check permanently whether there is a pressure drop. No change in pressure means that both sealing lines are tight.

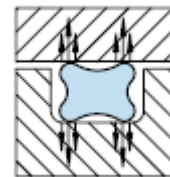

Main feature of the Q011 valve is to achieve two sealing lines with only one gasket and to monitor the spacing between the sealing lines. It is necessary to adjust the spacing exactly over a check boring. This is realized with an adjustable mechanical stop inside the valve body. Using the check boring the spacing between the sealing lines will be pressurized. This can be done continuously or follow scheduled intervals. The sealing element is a x-ring. A squaring is used as appointed as sealing element. Rubber materials are available in many different compounds. To achieve sufficient tightness, it is necessary to squeeze the rubber and built up an inner load. The deformation shall not be that much, the spacing between the sealing lines disappears. The depth of this spacing is exactly adjusted ex factory to have best sealing performance. The small spacing volume allows fast response of the testing device.

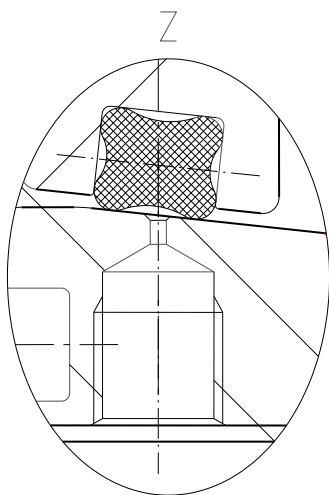

C3 Lubrication instruction

To achieve low actuation forces for closing the valve, silicon oil is applied to the gasket. If the valve is installed in pipeline, lubrication can be done using the check boring. To apply lubrication connect the lubrication pump to the coupling as shown on picture 3. Around 3 or 4 strokes with the pump lever should be sufficient to lubricate the valve completely.

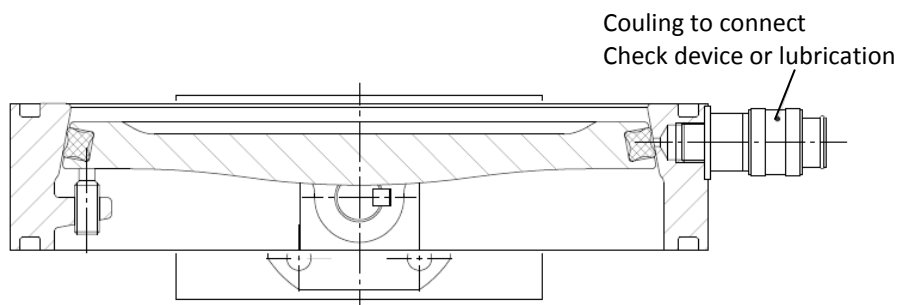

Picture 3

Lubrication shall be done every 3 months. Furthermore we recommend lubrication if any other maintenance (e.g. change of filters) is done at the plant.

C4 Manual Operation / Automatic Operation

The valve closes in a clockwise direction when actuated and opens in an anti-clockwise direction.

A butterfly valve with actuator must be actuated by the controller signals. Butterfly valves which have been supplied with an actuator ex factory, are set precisely ex factory – this setting in the gear mechanism/actuator should not be reset as long as the valve works properly.

The only maintenance required is a visual inspection at appropriate intervals of the tightness of the flange connection for media leaving the valve – if any leakage occurs see Section C5 <Troubleshooting>.

We recommend that you actuate butterfly valves which remain permanently in one position at regular intervals, in order to ensure continued free movement.

C5 Troubleshooting

Type of problem	Actions
Leaking from the flange connection to the pipe system	Seal the flange connection between the housing and pipe system: Follow instructions in the Operating manual for the pipe system and the installation instructions
Leakage from the shaft seal	<p>If any Leakage: Tighten the screw at the packing in small steps, until leakage stops. Don't tighten more than necessary.</p> <p><i>If leakage cannot be stopped</i> Repair is necessary: call for service</p> <p><i>If loosening or removing the screw (anti clockwise) at the packing</i></p> <div style="text-align: center;">  Hazard </div> <p>To protect the operating personnel be sure the pipeline on both sides of the valve is depressurized. Refer to section C1 <Safety instructions></p>
Leakage in seat-sealing	<p>Check whether the valve is 100% closed with full actuation torque.</p> <p><i>If the valve is still not tight when closed:</i> Open/close valve several times</p> <p><i>If the valve is still not tight:</i> Repair is necessary: call for service:</p>
Functional problems	<p>Dismantle valve (follow instructions from sections B1 and C1 <Safety instructions...>) and inspect.</p> <p><i>If the valve is damaged:</i> Repair needed: call for service.</p>

D) Technical Appendix / Planning documentation

Note:

This appendix is not an integral part of this operating manual and is only an extract of the catalogue pages for this valve type.

D1 Technical Specification of the valve

Butterfly valve, wafer type. Flange connection according customer requirements or DIN EN 12220.
Valve Body with o-ring grooves on both sides. O-rings in includes in supply.
All wetted metal components in material 1.4301 (304) or better

Gasket material: EPDM black

Operating temperature 0°C ... +50°C

Operating pressure +/- 10000Pa

allowable. Leakage $3 \times \text{DN} \times 3,6 \times 10^{-3}$ at 1 bar ambient pressure, 20°C and 2500Pa Differential pressure

Actuator connection according ISO 5211

D2 Drawing / bill of materials

Assigned drawings and part lists can be requested by manufacturer.

D3 Spare Parts

In the bill of materials in the datasheets described under section D2, the replacement parts are highlighted by the note "recommended spare part". Only original parts shall be fitted.

Declaration in compliance with EU-Directives

The manufacturer

EBRO Armaturen

**Gebr. Bröer GmbH
Karlstrasse 8
58135 Hagen
Deutschland**

declares that the valves

**EBRO-butterfly valves in excentric design
Series Q**

are manufactured in accordance with the requirements of the following standards:

prEN 12100:2009 Safety of machinery - General principles for design, risk assessment and risk reduction

Product documents are available on the following:

Planning documentation, Technical datasheets, catalogue pages

These products comply with the following directives:

Machine Directive 2006/42 EG (MRL) [applies if the valve is not actuated manually]

1. The products are a „partly completed machine“ under the terms of Art 2 g) of this Directive
2. The table overleaf lists whether and how the requirements of this Directive are met
3. This declaration is the Declaration of Incorporation under the terms of this Directive

To comply with the directive above, the following applies:

1. The user must comply with the <intended use>, defined in the „Original Assembly and Operating Manual“ (BA 5.8 MRL) supplied with the valve and must follow all instructions in this manual.
If this manual is not followed, the manufacturer may – in serious cases – be released from his product liability.
2. The valve must not be put into operation (and the fitted actuator if applicable) until the conformity to all applicable EU directives above of the system into which the valve is fitted has been declared by the persons responsible. A separate declaration is supplied for the actuator named above.
3. EBRO-Armaturen has conducted and documented the required risk analyses; the EBRO Armaturen employee responsible for this documentation is Ronald Meyer.

Hagen, 4.12.2009



Dirk Mischnick, Managing Director

The manufacturer	EBRO ARMATUREN Gebr. Bröer GmbH, D58135 Hagen
declares that the valve fitting Block and Bleed Valves Series Q complies with the following provisions:	
Requirement according to Annex I of the Machine Directive 2006/42/EG	
1.1.1, g) Intended use	See Assembly, Operating manual
1.1.2.,c) Warnings against incorrect use	See Assembly, Operating manual
1.1.2.,c) Required protective equipment	Exactly as per the pipe section into which the valve is fitted
1.1.2.,e) Accessories	No special tool required for changing consumable parts
1.1.3 Parts in contact with media	All materials coming into contact with media are specified in the type datasheet and in the order confirmation. The user is required to conduct an appropriate risk analysis.
1.1.5 Handling	Met through the instructions in the Assembly, Operating manual
1.2 and 6.2.11 Control	Responsibility of the user in accordance with the Assembly Manual of the actuator
1.3.2 Preventing risk of breakage	For pressure retaining parts of the valve: Certified through Declaration of Conformity with DGRL 97/23 EG. For functional parts: Guaranteed through intended use of actuator
1.3.4 Sharp corners and edges	Requirement met
1.3.7/8 Risk of injury through moved parts	Requirement met through intended use Maintenance and repair only when valve/actuator is not in operation
1.5.1 – 1.5.3 Power supply	Responsibility of user See also Assembly manual of actuator
1.5.5 Permitted temperature exceeded	See Warnings in Assembly, Operating Manual, Section <Intended Use>
1.5.7 -Explosion	⊕-protection required. Must be stated explicitly in Purchase Contract. In this case: Only use as directed on the valve
1.5.13 Emission of hazardous substances	Not applicable
1.6.1 Maintenance	See Operating manual. Discuss keeping stock of consumables with EBRO-Armaturen.
1.7.3 Labelling	Valve: According to assembly manual. Actuator: According to assembly manual.
1.7.4 Operating Manual	Any supplementary information required for the full manual of the <completed machine> are summarised in the Operating Manual document see Section C of the Assembly, Operating manual
Requirements according to Annex III	The valve is not a <complete machine>: No CE Mark for conformance to the MRL
Requirements according to Annex III and Annex VIII-XI	Not applicable
Requirement according to prEN 12100:2009	
1. Scope	The risk analysis for the valve/actuator is conducted from the perspective of a <partly completed machine>. The analysis has been based upon Product Standard EN593:<Block and Bleed valve with metal housing > with an actuator according to EN15714-2 or EN15714-3 , Class A . This is also based on industrial application and on average >20-years experience in using the above valve types. This has resulted in the instructions and warnings in the above assembly manual and operating manual. <i>Note:</i> <i>It is a prerequisite that the user conduct a risk analysis tailored to the application for the pipe section including the valves used, in accordance with Sections 4 to 6 of EN ISO 12100 – this cannot be done for EBRO Armaturen for standard valves.</i>
3.20, 6.1 inherently safe design	The butterfly valves are designed according to the principle of <inherently safe design>. The <intended use> is a prerequisite.
Analysis according to 4, 5 and 6	Based on knowledge of malfunctions recorded by the manufacturer and misuse within the context of a claim for damages (Documentation according to ISO9001).
5.3 Machine limits	The limits of the partly completed machine have been set according to the <intended use> of the valve as well as of the actuator
5.4 Decommissioning, disposal	Not within the responsibility of the manufacturer
6.2.2 Geometric Factors	Since the valve and the actuator enclose the function parts if used as intended, this section does not apply.
6.3 Technical protection equipment	Only required for special actuators – see order confirmation
6.4.5 Operating manual	Since valves with an actuator work „automatically“ according to the commands of the controller, those aspects which are <typical to the valve> are described in the operating manual and must be made available to the manufacturer of the pipe system
7 Risk analysis	The conducted risk analysis has been carried out according to Annex VII, B) by EBRO-Armaturen and is documented according to MRL Annex VII B).