

**Einbauhinweis PTFE - Klappen**  
*installation instruction PTFE lined valves*

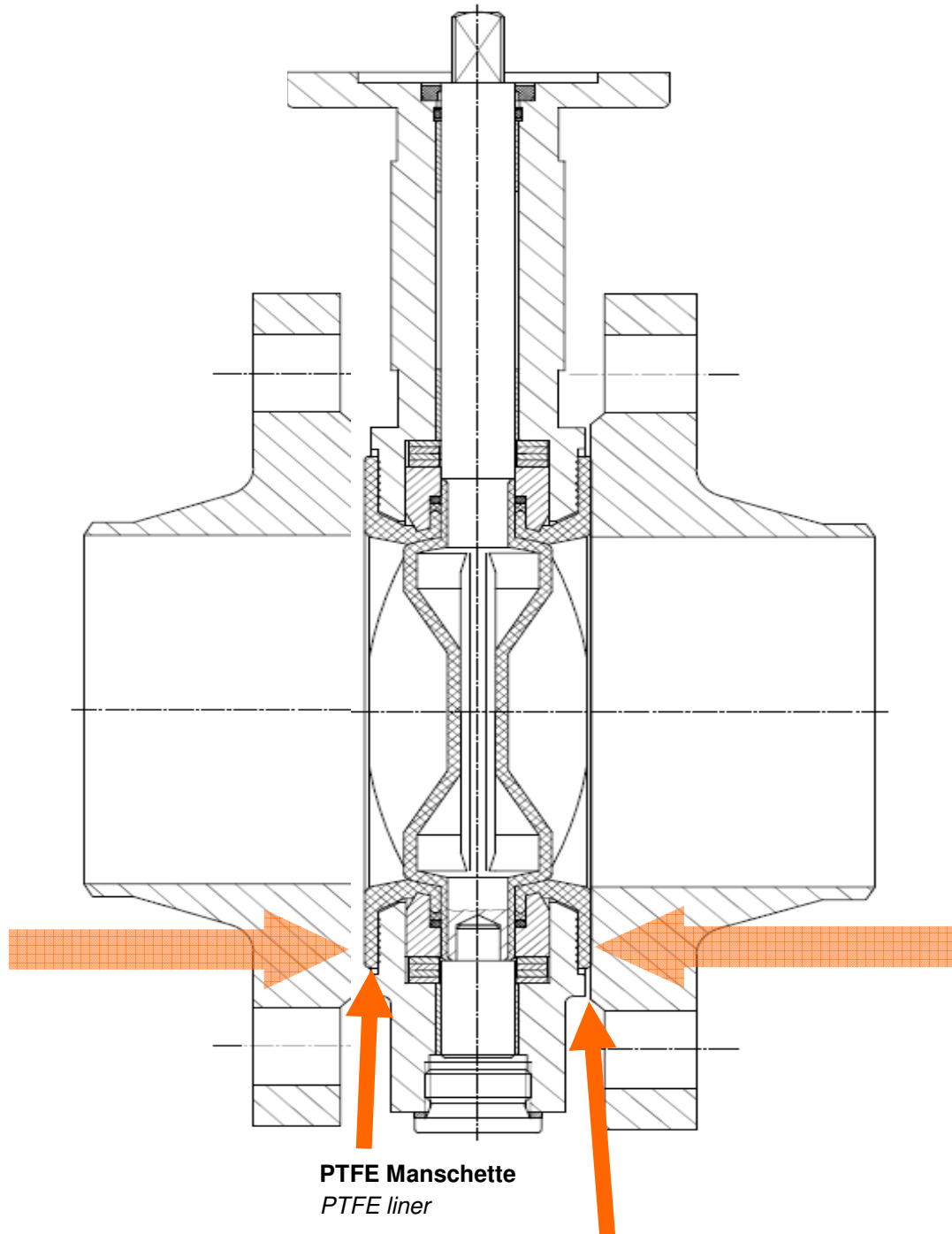

**erforderlicher Spalt / Freiraum zwischen Flansch und Gehäuse !**  
*necessary gap / space between body and flange !*

**Der Kontakt ist nur zwischen der PTFE Manschette und dem Flansch !**  
**Metallkontakt zwischen Flansch und dem Gehäuse ist nicht zulässig !**

*The Contact is only between PTFE liner and the flange !*  
*No metal contact is allowed between flange and body !*

**Fluorkunststoffe fließen ( langsam ) unter Belastung und erfordern eine konstante Dichtkraft**  
*Fluorplastic materials flow ( very slow = cold flow effect ) and require steadily seal stress*

Rev.	Revisionsgrund / reason of revision	Datum / date:	Bearbeiter/created by:	Geprüft/inspection	Prüfer/inspector
0	Erstellung / compilation	05.11.2009	B. Mitschke	05.11.2009	D. Wyen



Werksnorm EW:  
Works Standard EW:

1809

Blatt /  
sheet: 1

Seite/page :1/2

Anzugsmomente in Nm für Flanschschrauben Armatur Serie T200 + BE50/80  
*bolting torque [Nm] for flange bolts valve series T200 + BE50/80*

DN	Size	PN	Anzugsmoment erforderlich <i>required bolting torque</i>	Anzahl Schrauben <i>no. Of bolts</i>	Schrauben- größe <i>bolt</i>
[mm]	[inch]		[Nm]	[St. / pcs.]	[-]
50	2	10 + 16	<b>20-25</b>	4	M16
		Cl.150	<b>20-25</b>	4	5/8" UNC
65	2.1/2	10 + 16	<b>20-25</b>	4	M16
		Cl.150	<b>20-25</b>	4	5/8"
80	3	10 + 16	<b>15-20</b>	8	M16
		Cl.150	<b>35-40</b>	4	5/8"
100	4	10 + 16	<b>25-30</b>	8	M16
		Cl.150	<b>25-30</b>	8	5/8"
		25 + 40	<b>45-50</b>	8	M20
125	5	10 + 16	<b>30-35</b>	8	M16
		Cl.150	<b>30-40</b>	8	3/4"
150	6	10 + 16	<b>50-55</b>	8	M20
		Cl.150	<b>45-55</b>	8	3/4"
200	8	10	<b>70-80</b>	8	M20
		16	<b>45-55</b>	12	M20
		Cl.150	<b>65-75</b>	8	3/4"
250	10	10	<b>75-85</b>	12	M20
		16	<b>90-100</b>	12	M24
		Cl.150	<b>80-90</b>	12	7/8"
300	12	10	<b>85-100</b>	12	M20
		16	<b>105-115</b>	12	M24
		Cl.150	<b>95-110</b>	12	7/8"
350	14	10	<b>75-85</b>	16	M20
		16	<b>90-100</b>	16	M24
		Cl.150	<b>125-140</b>	12	1"
400	16	10	<b>110-120</b>	16	M24
		16	<b>120-135</b>	16	M27
		Cl.150	<b>110-125</b>	16	1"
450	18	10	<b>110-120</b>	20	M24
		16	<b>150-170</b>	16	M27
		Cl.150	<b>160-180</b>	16	1. 1/8"
500	20	10	<b>125-140</b>	20	M24
		16	<b>155-175</b>	20	M30
		Cl.150	<b>145-165</b>	20	1. 1/8"
600	24	10	<b>200-225</b>	20	M27
		16	<b>250-275</b>	20	M33
		Cl.150	<b>240-265</b>	20	1. 1/4"

Die Einhaltung dieser Schrauben Anzugsmomente ermöglicht den sicheren Betrieb der Armaturen.  
Fluorkunststoffe fließen ( langsam ) unter Belastung und erfordern eine konstante Dichtkraft.  
Flanschschrauben nach Inbetriebnahme der Anlage und/oder Erreichen der Betriebstemperatur nachziehen!

*Compliance with required bolt torque is necessary for secure operation.*

*Fluorplastic materials flow ( very slow ) and require steadily seal stress.*

*Flange bolts tracing by start of operation and/or achievement of the operation temperature !*

Rev.	Revisionsgrund /reason of revision	Datum / date:	Bearbeiter/created by:	Gepüft/inspection	Prüfer/inspector
0	Erstellung / compilation	05.11.2009	B. Mitschke	05.11.2009	D. Wyen
1	Ergänzung / addition	31.05.2010	B. Mitschke	31.05.2010	D. Wyen



Werksnorm EW:  
Works Standard EW:

1809

Blatt /  
sheet: 1

Seite/page :2/2

Anzugsmomente in Nm für Flanschschrauben Armatur Serie T200 + BE50/80  
*bolting torque [Nm] for flange bolts valve series T200 + BE50/80*

DN	Size	Serie	PN	Anzugsmoment erforderlich <i>required bolting torque</i>	Anzahl Schrauben <i>no. Of bolts</i>	Schrauben- größe <i>bolt</i>
[mm]	[inch]	[-]		[Nm]	[St. / pcs.]	[-]
700			10	<b>345</b>	24	M27
700			16	<b>410</b>	24	M33
700		A	Cl.150	<b>345</b>	28	1.1/4"
700		B	Cl.150	<b>105</b>	40	3/4"
750		A	Cl.150	<b>415</b>	28	1.1/4"
750		B	Cl.150	<b>115</b>	44	3/4"
800			6	<b>405</b>	24	M27
800			10	<b>450</b>	24	M30
800			16	<b>535</b>	24	M36
800		A	Cl.150	<b>480</b>	28	1.1/2"
800		B	Cl.150	<b>130</b>	48	3/4"
900			10	<b>550</b>	28	M30
900			16	<b>650</b>	28	M36
900		A	Cl.150	<b>595</b>	32	1.1/2"
900		B	Cl.150	<b>170</b>	44	1"

Die Einhaltung dieser Schrauben Anzugsmomente ermöglicht den sicheren Betrieb der Armaturen.

Fluorkunststoffe fließen ( langsam ) unter Belastung und erfordern eine konstante Dichtkraft.

Flanschschrauben nach Inbetriebnahme der Anlage und/oder Erreichen der Betriebstemperatur nachziehen!

*Compliance with required bolt torque is necessary for secure operation.*

*Fluorplastic materials flow ( very slow ) and require steadily seal stress.*

*Flange bolts tracing by start of operation and/or achievement of the operation temperature !*

### Hinweis:

Grundlage für die Berechnung des erforderlichen Anzugsmomentes ist eine Gesamtreibungszahl der Schraube von 0,12.

Je nach Beschichtung und Schmierung der Schraube kann dieser Wert, und damit das Anzugsmoment, abweichen!

### Notice:

*Basic principle calculation of the required bolting torque is an overall coefficient of friction of 0.12.*

*Depending on coating or lubrication thes value, and so the bolting torque too, can deviate.*

Rev.	Revisionsgrund /reason of revision	Datum / date:	Bearbeiter/created by:	Geprüft/inspection	Prüfer/inspector
0	Erstellung / compilation	05.11.2009	B. Mitschke	05.11.2009	D. Wyen
1	Ergänzung / addition	31.05.2010	B. Mitschke	31.05.2010	D. Wyen

## T212 Flansch-Schrauben / flange bolting

Einbauhinweis EW1807 + Anzugsmomente EW1809 beachten!  
*respect installation instruction EW1807 + bolting torque EW 1809 !*

Bei der Schraubenauswahl ist für den Gegenflansch die angegebene Flanschdicke berücksichtigt,  
die tatsächliche vorhandene Flanschdicke ist kundenseitig zu prüfen und die Schraubenlängen entsprechend anzupassen!

*selection of the bolts by allowance counter flange thickness as denoted,  
the effectively existing flange thickness is to check by the customer and the bolt length proportionately customize*

Längenmaße angegeben in mm

length dimensions specified in mm

Zoll-Gewinde nach ASME B1.1-1989 UNC bis Gewinde 1"; Für Gewinde >1" gilt Steigung 8 UN / Inch thread acc. ASME B1.1-1989 UNC up to thread 1"; for thread >1" = 8 UN

Bemerkung / comment :

Sonderausführung nach Auftrag!  
*special type only acc. order!*

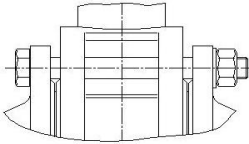
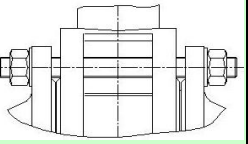
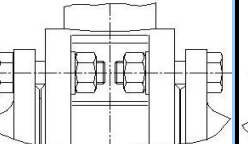
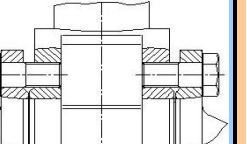
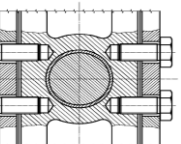
DN	Size	Flanschanschluss / Flanged Connection	Einbaumaß Face - to - face	Verbindungsart Connection Verb. 4 = beachte Bemerkung! Conn. 4 = notice comment!	Lochanzahl Number of Bolts	Gegen-Flanschdicke counter flange thickness	 Verbindungsart 1 / Connection 1 Schraube / screw	 Verbindungsart 2 / Connection 2 Gewindestange / threaded both	 Verbindungsart 3 / Connection 3 Schraube / screw	 Verbindungsart 4 / Connection 4 Schraube / screw	 Verbindungsart 5 / Connection 5 Schraube / screw
350	14"	PN 6	92			22	not available	not available	not available	not available	not required
350	14"	PN 10	92	1 or 2 or 4 + 5	16	26	8 x M20 x 170	8 x M20 x 200	not available	16 x M20 x 55	16 x M20 x 60
350	14"	PN 16	92	1 or 2 or 4 + 5	16	30	8 x M24 x 190	8 x M24 x 220	not available	16 x M24 x 60	16 x M24 x 70
350	14"	JIS 5K	92			24	not available	not available	not available	not available	not required
350	14"	JIS 10K	92	1 or 2 or 4 + 5	16	26	8 x M22 x 170	8 x M22 x 200	not available	16 x M22 x 55	16 x M22 x 55
350	14"	JIS 16K	92			34	not available	not available	not available	not available	not required
350	14"	ASME B16.5 cl. 150	92	1 or 2 or 4 + 5	12	35,1	4 x 1"- 8UNC x 200	4 x 1"- 8UNC x 230	not available	8 x 1"- 8UNC x 65	16 x 1"- 8UNC x 75
350	14"	AWWA C 207 cl. B + D	92			19,1	not available	not available	not available	not available	not required
350	14"	AWWA C 207 cl. E	92			34,9	not available	not available	not available	not available	not required
350	14"	AS 2129 - Table D	92	1 or 2 or 4 + 5	12	29	4 x M24 x 180	4 x M24 x 210	not available	8 x M24 x 60	16 x M24 x 70
350	14"	AS 2129 - Table E	92	1 or 2 or 4 + 5	12	32	4 x M24 x 190	4 x M24 x 220	not available	8 x M24 x 60	16 x M24 x 70
400	16"	PN 6	102	4 + 5	16	22	not available	not available	not available	24 x M20 x 55	8 x M20 x 45
400	16"	PN 10	102	1 or 2 or 4 + 5	16	26	8 x M24 x 190	8 x M24 x 220	not available	16 x M24 x 60	16 x M24 x 70
400	16"	PN 16	102	1 or 2 or 4 + 5	16	32	8 x M27 x 200	8 x M27 x 230	not available	16 x M27 x 65	16 x M27 x 75
400	16"	JIS 5K	102			24	not available	not available	not available	not available	not required
400	16"	JIS 10K	102			28	not available	not available	not available	not available	not required
400	16"	JIS 16K	102			38	not available	not available	not available	not available	not required
400	16"	ASME B16.5 cl. 150	102	1 or 2 or 4 + 5	16	36,6	8 x 1"- 8UNC x 210	8 x 1"- 8UNC x 240	not available	16 x 1"- 8UNC x 70	16 x 1"- 8UNC x 80
400	16"	AWWA C 207 cl. B + D	102			19,1	not available	not available	not available	not available	not required
400	16"	AWWA C 207 cl. E	102			36,5	not available	not available	not available	not available	not required

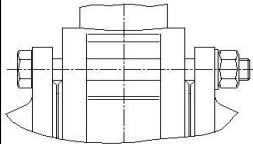
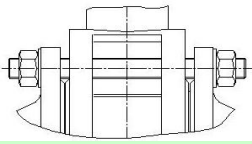
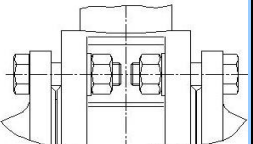
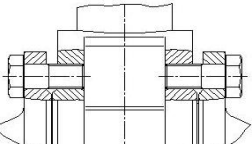
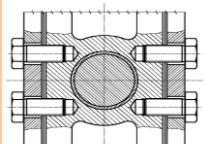
DN	Size	Flanschanschluss / Flanged Connection	Einbaumaß Face - to - face	Verbindungsart Connection Verb. 4 = beachte Bemerkung! Conn. 4 = notice comment!	Lochanzahl Number of Bolts	Gegen-Flanshdicke counter flange thickness					
							Verbindungsart 1 / Connection 1 Schraube / screw	Verbindungsart 2 / Connection 2 Gewindestange / threaded both	Verbindungsart 3 / Connection 3 Schraube / screw	Verbindungsart 4 / Connection 4 Schraube / screw	Verbindungsart 5 / Connection 5 Schraube / screw
400	16"	AS 2129 - Table D	102	1 or 2 or 4 + 5	12	29	4 x M24 x 190	4 x M24 x 220	not available	8 x M24 x 65	16 x M24 x 70
400	16"	AS 2129 - Table E	102	1 or 2 or 4 + 5	12	32	4 x M24 x 200	4 x M24 x 230	not available	8 x M24 x 65	16 x M24 x 70
450	18"	PN 6	114			22	not available	not available	not available	not available	not required
450	18"	PN 10	114	1 or 2 or 4 + 5	20	28	12 x M24 x 200	12 x M24 x 230	not available	24 x M24 x 60	16 x M24 x 55
450	18"	PN 16	114	1 or 2 or 4 + 5	20	40	12 x M27 x 230	12 x M27 x 260	not available	24 x M27 x 75	16 x M27 x 70
450	18"	JIS 5K	114			24	not available	not available	not available	not available	not required
450	18"	JIS 10K	114			30	not available	not available	not available	not available	not required
450	18"	JIS 16K	114			40	not available	not available	not available	not available	not required
450	18"	ASME B16.5 cl. 150	114	1 or 2 or 4 + 5	16	39,6	8 x 1 1/8"- 8UN x 230	8 x 1 1/8"- 8UN x 270	not available	16 x 1 1/8"- 8UN x 75	16 x 1 1/8"- 8UN x 75
450	18"	AWWA C 207 cl. B + D	114			19,1	not available	not available	not available	not available	not required
450	18"	AWWA C 207 cl. E	114			39,7	not available	not available	not available	not available	not required
450	18"	AS 2129 - Table D	114	1 or 2 or 4 + 5	12	32	4 x M24 x 210	4 x M24 x 240	not available	8 x M24 x 65	16 x M24 x 60
450	18"	AS 2129 - Table E	114	1 or 2 or 4 + 5	16	35	8 x M24 x 220	8 x M24 x 250	not available	16 x M24 x 70	16 x M24 x 65
500	20"	PN 6	127	1 or 2 or 3 or 4 + 5	20	24	12 x M20 x 200	12 x M20 x 230	24 x M20 x 85	24 x M20 x 60	16 x M20 x 45
500	20"	PN 10	127	1 or 2 or 4 + 5	20	28	12 x M24 x 220	12 x M24 x 250	not available	24 x M24 x 65	16 x M24 x 55
500	20"	PN 16	127	1 or 2 or 4 + 5	20	44	12 x M30 x 250	12 x M30 x 290	not available	24 x M30 x 80	16 x M30 x 80
500	20"	JIS 5K	127			24	not available	not available	not available	not available	not required
500	20"	JIS 10K	127			30	not available	not available	not available	not available	not required
500	20"	JIS 16K	127			40	not available	not available	not available	not available	not required
500	20"	ASME B16.5 cl. 150	127	1 or 2 or 4 + 5	20	42,9	12 x 1 1/8"- 8UN x 250	12 x 1 1/8"- 8UN x 290	not available	24 x 1 1/8"- 8UN x 80	16 x 1 1/8"- 8UN x 80
500	20"	AWWA C 207 cl. B + D	127			19,1	not available	not available	not available	not available	not required
500	20"	AWWA C 207 cl. E	127			42,9	not available	not available	not available	not available	not required
500	20"	AS 2129 - Table D	127	1 or 2 or 4 + 5	16	32	8 x M24 x 230	8 x M24 x 260	not available	16 x M24 x 70	16 x M24 x 60
500	20"	AS 2129 - Table E	127	1 or 2 or 4 + 5	16	38	8 x M24 x 240	8 x M24 x 270	not available	16 x M24 x 75	16 x M24 x 65
600	24"	PN 6	154			30	not available	not available	not available	not available	not required
600	24"	PN 10	154	1 or 2 or 3 or 4 + 5	20	28	12 x M27 x 250	12 x M27 x 280	24 x M27 x 95	24 x M27 x 65	16 x M27 x 60
600	24"	PN 16	154	1 or 2 or 3 or 4 + 5	20	54	12 x M33 x 310	12 x M33 x 340	24 x M33 x 130	24 x M33 x 90	16 x M33 x 95
600	24"	JIS 5K	154			26	not available	not available	not available	not available	not required
600	24"	JIS 10K	154			32	not available	not available	not available	not available	not required
600	24"	JIS 16K	154			46	not available	not available	not available	not available	not required

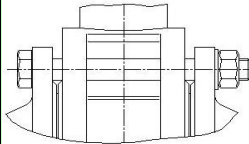
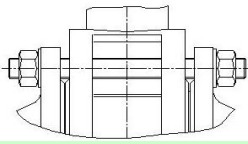
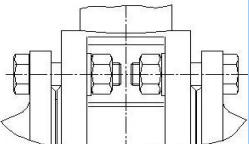
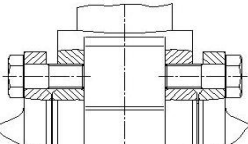
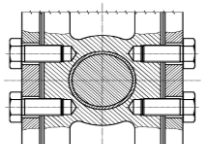

DN	Size	Flanschanschluss / Flanged Connection	Einbaumaß Face - to - face	Verbindungsart Connection <small>Verb. 4 = beachte Bemerkung! Conn. 4 = notice comment!</small>	Lochanzahl Number of Bolts	Gegen-Flanschdicke counter flange thickness	 Verbindungsart 1 / Connection 1 Schraube / screw	 Verbindungsart 2 / Connection 2 Gewindestange / threaded both	 Verbindungsart 3 / Connection 3 Schraube / screw	 Verbindungsart 4 / Connection 4 Schraube / screw	 Verbindungsart 5 / Connection 5 Schraube / screw
600	24"	ASME B16.5 cl. 150-B	154	1 or 2 or 4	20	47,8	20 x 1 1/4"- 8UN x 290	20 x 1 1/4"- 8UN x 330	not available	40 x 1 1/4"- 8UN x 85	not required
600	24"	AWWA C 207 cl. B + D	154			25,4	not available	not available	not available	not available	not required
600	24"	AWWA C 207 cl. E	154			47,8	not available	not available	not available	not available	not required
600	24"	AS 2129 - Table C	154			41	not available	not available	not available	not available	not required
600	24"	AS 2129 - Table D	154	1 or 2 or 3 or 4 + 5	16	35	8 x M27 x 260	8 x M27 x 290	16 x M27 x 110	16 x M27 x 70	16 x M27 x 65
600	24"	AS 2129 - Table E	154	1 or 2 or 3 or 4 + 5	16	41	8 x M30 x 270	8 x M30 x 310	16 x M30 x 110	16 x M30 x 80	16 x M30 x 75
700	28"	PN 6	165	1 or 2 or 4	24	24	24 x M24 x 250	24 x M24 x 280	not available	48 x M24 x 80	not required
700	28"	PN 10	165	1 or 2 or 4 + 5	24	30	20 x M27 x 260	20 x M27 x 290	not available	40 x M27 x 85	8 x M27 x 65
700	28"	PN 16	165	1 or 2 or 4 + 5	24	36	20 x M33 x 280	20 x M33 x 320	not available	40 x M33 x 90	8 x M33 x 70
700	28"	JIS 5K	165			26	not available	not available	not available	not available	not required
700	28"	JIS 10K	165			34	not available	not available	not available	not available	not required
700	28"	JIS 16K	165			48	not available	not available	not available	not available	not required
700	28"	ASME B16.47 cl. 150-A	165	1 or 2 or 4 + 5	28	71,4	24 x 1 1/4"- 8UN x 350	24 x 1 1/4"- 8UN x 390	not available	48 x 1 1/4"- 8UN x 130	8 x 1 1/4"- 8UN x 100
700	28"	ASME B16.47 cl. 150-B	165	1 or 2 or 4 + 5	40	44,5	36 x 3/4"-10UNC x 280	36 x 3/4"-10UNC x 310	not available	72 x 3/4"-10UNC x 100	8 x 3/4"-10UNC x 60
700	28"	AWWA C 207 cl. B + D	165			25,4	not available	not available	not available	not available	not required
700	28"	AWWA C 207 cl. E	165			52,4	not available	not available	not available	not available	not required
700	28"	AS 2129 - Table C	165				not available	not available	not available	not available	not required
700	28"	AS 2129 - Table D	165	1 or 2 or 4	20	38	20 x M27 x 280	20 x M27 x 310	not available	40 x M27 x 100	not required
700	28"	AS 2129 - Table E	165	1 or 2 or 4	20	44	20 x M30 x 290	20 x M30 x 330	not available	40 x M30 x 100	not required
750		PN 6	165				not available	not available	not available	not available	not required
750		PN 10	165				not available	not available	not available	not available	not required
750		PN 16	165				not available	not available	not available	not available	not required
750		JIS 5K	165			28	not available	not available	not available	not available	not required
750		JIS 10K	165			36	not available	not available	not available	not available	not required
750		JIS 16K	165			52	not available	not available	not available	not available	not required
750		ASME B16.47 cl. 150-A	165	1 or 2 or 4 + 5	28	74,7	24 x 1/4"-8 UN x 360	24 x 1/4"-8 UN x 400	not available	48 x 1/4"-8 UN x 140	8 x 1/4"-8 UN x 100
750		ASME B16.47 cl. 150-B	165	1 or 2 or 4 + 5	44	44,5	40 x 3/4"-10UNC x 280	40 x 3/4"-10UNC x 310	not available	80 x 3/4"-10UNC x 110	8 x 3/4"-10UNC x 60
750		AWWA C 207 cl. B + D	165			25,4	not available	not available	not available	not available	not required
750		AWWA C 207 cl. E	165			54	not available	not available	not available	not available	not required

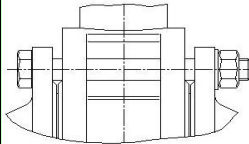
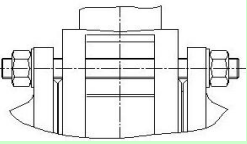
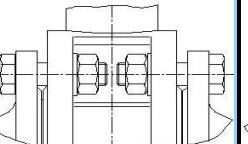
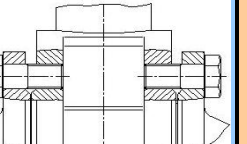
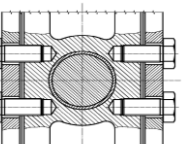
DN	Size	Flanschanschluss / Flanged Connection	Einbaumaß Face - to - face	Verbindungsart Connection <small>Verb. 4 = beachte Bemerkung! Conn. 4 = notice comment!</small>	Lochanzahl Number of Bolts	Gegen-Flansdicke counter flange thickness	 Verbindungsart 1 / Connection 1 Schraube / screw	 Verbindungsart 2 / Connection 2 Gewindestange / threaded both	 Verbindungsart 3 / Connection 3 Schraube / screw	 Verbindungsart 4 / Connection 4 Schraube / screw	 Verbindungsart 5 / Connection 5 Schraube / screw
750		AS 2129 - Table C	165				not available	not available	not available	not available	not required
750		AS 2129 - Table D	165			41	not available	not available	not available	not available	not required
750		AS 2129 - Table E	165			48	not available	not available	not available	not available	not required
800	32"	PN 6	190	1 or 2 or 3 or 4 + 5	24	24	20 x M27 x 270	20 x M27 x 310	40 x M27 x 110	40 x M27 x 80	8 x M27 x 75
800	32"	PN 10	190	1 or 2 or 3 or 4 + 5	24	32	20 x M30 x 290	20 x M30 x 330	40 x M30 x 120	40 x M30 x 85	8 x M30 x 85
800	32"	PN 16	190	1 or 2 or 4 + 5	24	38	20 x M36 x 310	20 x M36 x 350	not available	40 x M36 x 90	8 x M36 x 85
800	32"	JIS 5K	190			28	not available	not available	not available	not available	not required
800	32"	JIS 10K	190			36	not available	not available	not available	not available	not required
800	32"	JIS 16K	190			54	not available	not available	not available	not available	not required
800	32"	ASME B16.47 cl. 150-A	190	1 or 2 or 4 + 5	28	46,2	24 x 1 1/2"-8 UN x 330	24 x 1 1/2"-8 UN x 380	not available	48 x 1 1/2"-8 UN x 100	8 x 1 1/2"-8 UN x 90
800	32"	ASME B16.47 cl. 150-B	190	1 or 2 or 3 or 4 + 5	48	46	44 x 3/4"-10 UNC x 310	44 x 3/4"-10 UNC x 340	88 x 3/4"-10 UNC x 130	88 x 3/4"-10 UNC x 100	8 x 3/4"-10 UNC x 75
800	32"	AWWA C 207 cl. B + D	190			28,6	not available	not available	not available	not available	not required
800	32"	AWWA C 207 cl. E	190			57,2	not available	not available	not available	not available	not required
800	32"	AS 2129 - Table C	190				not available	not available	not available	not available	not required
800	32"	AS 2129 - Table D	190	1 or 2 or 3 or 4	20	41	20 x M33 x 320	20 x M33 x 350	40 x M33 x	40 x M33 x 95	not required
800	32"	AS 2129 - Table E	190	1 or 2 or 3 or 4	20	48	20 x M33 x 330	20 x M33 x 370	40 x M33 x	40 x M33 x 100	not required
900	36"	PN 6	203			26	not available	not available	not available	not available	not required
900	36"	PN 10	203	1 or 2 or 3 or 4 + 5	28	34	20 x M30 x 310	20 x M30 x 340	40 x M30 x 120	40 x M30 x 90	16 x M30 x 80
900	36"	PN 16	203	1 or 2 or 3 or 4 + 5	28	40	20 x M36 x 330	20 x M36 x 370	40 x M36 x	40 x M36 x 100	16 x M36 x 85
900	36"	JIS 5K	203			30	not available	not available	not available	not available	not required
900	36"	JIS 10K	203			38	not available	not available	not available	not available	not required
900	36"	JIS 16K	203			58	not available	not available	not available	not available	not required
900	36"	ASME B16.47 cl. 150-A	203	1 or 2 or 3 or 4 + 5	32	88,8	24 x 1 1/2"-8 UN x 430	24 x 1 1/2"-8 UN x 480	48 x 1 1/2"-8 UN x	48 x 1 1/2"-8 UN x 150	16 x 1 1/2"-8 UN x 120
900	36"	ASME B16.47 cl. 150-B	203	1 or 2 or 3 or 4 + 5	44	52,3	36 x 1"- 8UNC x 340	36 x 1"- 8UNC x 380	72 x 1"- 8UNC x	72 x 1"- 8UNC x 110	16 x 1"- 8UNC x 80
900	36"	AWWA C 207 cl. B + D	203			28,6	not available	not available	not available	not available	not required
900	36"	AWWA C 207 cl. E	203			60,3	not available	not available	not available	not available	not required
900	36"	AS 2129 - Table C	203				not available	not available	not available	not available	not required
900	36"	AS 2129 - Table D	203			44	not available	not available	not available	not available	not required
900	36"	AS 2129 - Table E	203			51	not available	not available	not available	not available	not required