

Einbauhinweis PTFE - Klappen
installation instruction PTFE lined valves

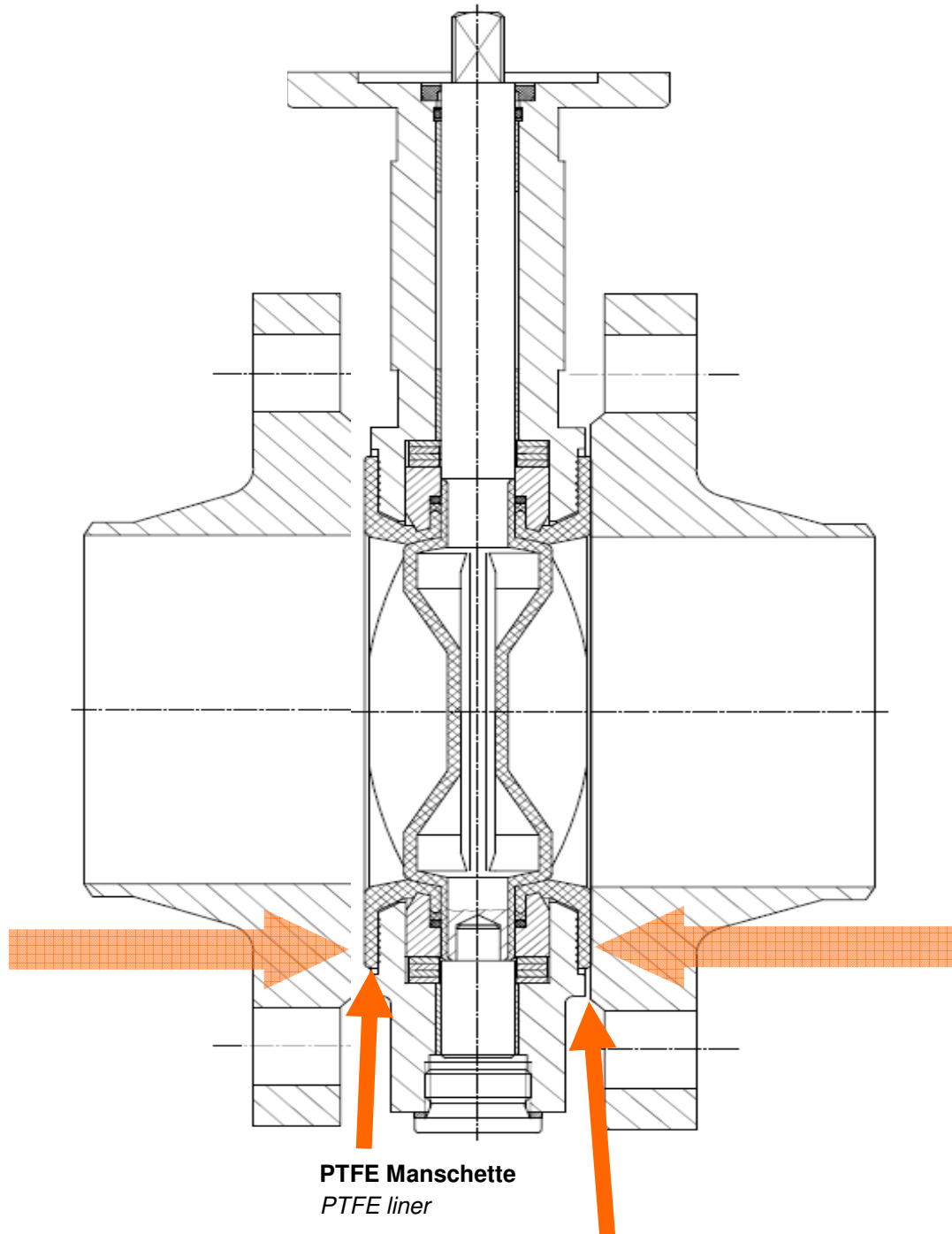

erforderlicher Spalt / Freiraum zwischen Flansch und Gehäuse !
necessary gap / space between body and flange !

Der Kontakt ist nur zwischen der PTFE Manschette und dem Flansch !
Metallkontakt zwischen Flansch und dem Gehäuse ist nicht zulässig !

The Contact is only between PTFE liner and the flange !

No metal contact is allowed between flange and body !

Fluorkunststoffe fließen (langsam) unter Belastung und erfordern eine konstante Dichtkraft
Fluorplastic materials flow (very slow = cold flow effect) and require steadily seal stress

Rev.	Revisionsgrund / reason of revision	Datum / date:	Bearbeiter/created by:	Geprüft/inspection	Prüfer/inspector
0	Erstellung / compilation	05.11.2009	B. Mitschke	05.11.2009	D. Wyen



Werksnorm EW:
Works Standard EW:

1809

Blatt /
sheet: 1

Seite/page :1/2

Anzugsmomente in Nm für Flanschschrauben Armatur Serie T200 + BE50/80
bolting torque [Nm] for flange bolts valve series T200 + BE50/80

DN	Size	PN	Anzugsmoment erforderlich <i>required bolting torque</i> [Nm]	Anzahl Schrauben <i>no. Of bolts</i> [St. / pcs.]	Schrauben- größe <i>bolt</i> [-]
[mm]	[inch]				
50	2	10 + 16	20-25	4	M16
		Cl.150	20-25	4	5/8" UNC
65	2.1/2	10 + 16	20-25	4	M16
		Cl.150	20-25	4	5/8"
80	3	10 + 16	15-20	8	M16
		Cl.150	35-40	4	5/8"
100	4	10 + 16	25-30	8	M16
		Cl.150	25-30	8	5/8"
		25 + 40	45-50	8	M20
125	5	10 + 16	30-35	8	M16
		Cl.150	30-40	8	3/4"
150	6	10 + 16	50-55	8	M20
		Cl.150	45-55	8	3/4"
200	8	10	70-80	8	M20
		16	45-55	12	M20
		Cl.150	65-75	8	3/4"
250	10	10	75-85	12	M20
		16	90-100	12	M24
		Cl.150	80-90	12	7/8"
300	12	10	85-100	12	M20
		16	105-115	12	M24
		Cl.150	95-110	12	7/8"
350	14	10	75-85	16	M20
		16	90-100	16	M24
		Cl.150	125-140	12	1"
400	16	10	110-120	16	M24
		16	120-135	16	M27
		Cl.150	110-125	16	1"
450	18	10	110-120	20	M24
		16	150-170	16	M27
		Cl.150	160-180	16	1. 1/8"
500	20	10	125-140	20	M24
		16	155-175	20	M30
		Cl.150	145-165	20	1. 1/8"
600	24	10	200-225	20	M27
		16	250-275	20	M33
		Cl.150	240-265	20	1. 1/4"

Die Einhaltung dieser Schrauben Anzugsmomente ermöglicht den sicheren Betrieb der Armaturen.

Fluorkunststoffe fließen (langsam) unter Belastung und erfordern eine konstante Dichtkraft.

Flanschschrauben nach Inbetriebnahme der Anlage und/oder Erreichen der Betriebstemperatur nachziehen!

Compliance with required bolt torque is necessary for secure operation.

Fluorplastic materials flow (very slow) and require steadily seal stress.

Flange bolts tracing by start of operation and/or achievement of the operation temperature !

Rev.	Revisionsgrund /reason of revision	Datum / date:	Bearbeiter/created by:	Gepüft/inspection	Prüfer/inspector
0	Erstellung / compilation	05.11.2009	B. Mitschke	05.11.2009	D. Wyen
1	Ergänzung / addition	31.05.2010	B. Mitschke	31.05.2010	D. Wyen



Werksnorm EW:
Works Standard EW:

1809

Blatt /
sheet: 1

Seite/page :2/2

Anzugsmomente in Nm für Flanschschrauben Armatur Serie T200 + BE50/80
bolting torque [Nm] for flange bolts valve series T200 + BE50/80

DN	Size	Serie	PN	Anzugsmoment erforderlich <i>required bolting torque</i>	Anzahl Schrauben <i>no. Of bolts</i>	Schrauben- größe <i>bolt</i>
[mm]	[inch]	[-]		[Nm]	[St. / pcs.]	[-]
700			10	345	24	M27
700			16	410	24	M33
700		A	Cl.150	345	28	1.1/4"
700		B	Cl.150	105	40	3/4"
750		A	Cl.150	415	28	1.1/4"
750		B	Cl.150	115	44	3/4"
800			6	405	24	M27
800			10	450	24	M30
800			16	535	24	M36
800		A	Cl.150	480	28	1.1/2"
800		B	Cl.150	130	48	3/4"
900			10	550	28	M30
900			16	650	28	M36
900		A	Cl.150	595	32	1.1/2"
900		B	Cl.150	170	44	1"

Die Einhaltung dieser Schrauben Anzugsmomente ermöglicht den sicheren Betrieb der Armaturen.
Fluorkunststoffe fließen (langsam) unter Belastung und erfordern eine konstante Dichtkraft.
Flanschschrauben nach Inbetriebnahme der Anlage und/oder Erreichen der Betriebstemperatur nachziehen!

*Compliance with required bolt torque is necessary for secure operation.
Fluorplastic materials flow (very slow) and require steadily seal stress.
Flange bolts tracing by start of operation and/or achievement of the operation temperature !*

Hinweis:

Grundlage für die Berechnung des erforderlichen Anzugsmomentes ist eine Gesamtreibungszahl der Schraube von 0,12.
Je nach Beschichtung und Schmierung der Schraube kann dieser Wert, und damit das Anzugsmoment, abweichen!

Notice:

*Basic principle calculation of the required bolting torque is an overall coefficient of friction of 0.12.
Depending on coating or lubrication thes value, and so the bolting torque too, can deviate.*

Rev.	Revisionsgrund /reason of revision	Datum / date:	Bearbeiter/created by:	Geprüft/inspection	Prüfer/inspector
0	Erstellung / compilation	05.11.2009	B. Mitschke	05.11.2009	D. Wyen
1	Ergänzung / addition	31.05.2010	B. Mitschke	31.05.2010	D. Wyen

T211 Flansch-Schrauben / flange bolting

Einbauhinweis EW1807 + Anzugsmomente EW1809 beachten!
respect installation instruction EW1807 + bolting torque EW 1809!

Bei der Schraubenauswahl ist für den Gegenflansch die angegebene Flanschdicke berücksichtigt,
die tatsächliche vorhandene Flanschdicke ist kundenseitig zu prüfen und die Schraubenlängen entsprechend anzupassen!

*selection of the bolts by allowance counter flange thickness as denoted,
the effectively existing flange thickness is to check by the customer and the bolt length proportionately customize*

Längenmaße angegeben in mm

length dimensions specified in mm

Zoll-Gewinde nach ASME B1.1-1989 UNC bis Gewinde 1"; Für Gewinde >1" gilt Steigung 8 UN / Inch thread acc. ASME B1.1-1989 UNC up to thread 1"; for thread >1" = 8 UN

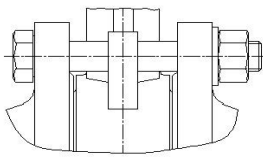
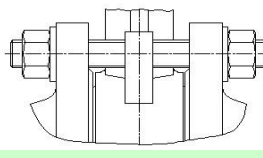
DN	Size	Flanschanschluss / Flanged Connection	Einbaumaß Face - to - face	Verbindungsart Connection	Lochanzahl Number of Bolts	Gegen-Flanschdicke counter flange thickness	 Verbindungsart 1 / Connection 1 Schraube / screw	 Verbindungsart 2 / Connection 2 Gewindestange / threaded both
50	2"	PN 6	46	1 oder (or) 2	4	14	4 x M12 x 90	4 x M12 x 110
50	2"	PN 10	46	1 oder (or) 2	4	18	4 x M16 x 110	4 x M16 x 130
50	2"	PN 16	46	1 oder (or) 2	4	18	4 x M16 x 110	4 x M16 x 130
50	2"	JIS 5K	46	1 oder (or) 2	4	14	4 x M12 x 90	4 x M12 x 110
50	2"	JIS 10K	46	1 oder (or) 2	4	16	4 x M16 x 100	4 x M16 x 120
50	2"	JIS 16K	46	1 oder (or) 2	8	16	8 x M16 x 100	8 x M16 x 120
50	2"	ASME B16.5 cl. 150	46	1 oder (or) 2	4	19,1	4 x 5/8"- 11UNC x 110	4 x 5/8"- 11UNC x 130
50	2"	AS 2129 - Table D	46	1 oder (or) 2	4	17	4 x M16 x 100	4 x M16 x 130
50	2"	AS 2129 - Table E	46	1 oder (or) 2	4	19	4 x M16 x 110	4 x M16 x 130
65	2 1/2"	PN 6	46	1 oder (or) 2	4	14	4 x M12 x 90	4 x M12 x 110
65	2 1/2"	PN 10	46	1 oder (or) 2	4	18	4 x M16 x 110	4 x M16 x 130
65	2 1/2"	PN 16	46	1 oder (or) 2	4	18	4 x M16 x 110	4 x M16 x 130
65	2 1/2"	JIS 5K	46	1 oder (or) 2	4	14	4 x M12 x 90	4 x M12 x 110
65	2 1/2"	JIS 10K	46	1 oder (or) 2	4	18	4 x M16 x 110	4 x M16 x 130
65	2 1/2"	JIS 16K	46	1 oder (or) 2	8	18	8 x M16 x 110	8 x M16 x 130
65	2 1/2"	ASME B16.5 cl. 150	46	1 oder (or) 2	4	22,4	4 x 5/8"- 11UNC x 120	4 x 5/8"- 11UNC x 140
65	2 1/2"	AS 2129 - Table D	46	1 oder (or) 2	4	17	4 x M16 x 100	4 x M16 x 130
65	2 1/2"	AS 2129 - Table E	46	1 oder (or) 2	4	19	4 x M16 x 110	4 x M16 x 130
80	3"	PN 6	46	1 oder (or) 2	4	16	4 x M16 x 100	4 x M16 x 120
80	3"	PN 10	46	1 oder (or) 2	8	20	8 x M16 x 110	8 x M16 x 130
80	3"	PN 16	46	1 oder (or) 2	8	20	8 x M16 x 110	8 x M16 x 130
80	3"	JIS 5K	46	1 oder (or) 2	4	14	4 x M16 x 100	4 x M16 x 120
80	3"	JIS 10K	46	1 oder (or) 2	8	18	8 x M16 x 110	8 x M16 x 130
80	3"	JIS 16K	46	1 oder (or) 2	8	20	8 x M20 x 110	8 x M20 x 140
80	3"	ASME B16.5 cl. 150	46	1 oder (or) 2	4	23,9	4 x 5/8"- 11UNC x 120	4 x 5/8"- 11UNC x 140
80	3"	AS 2129 - Table D	46	1 oder (or) 2	4	19	4 x M16 x 110	4 x M16 x 130
80	3"	AS 2129 - Table E	46	1 oder (or) 2	4	19	4 x M16 x 110	4 x M16 x 130

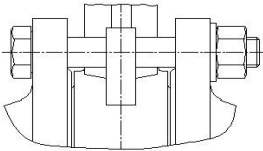
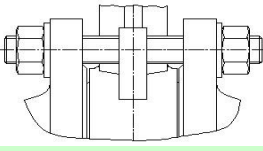
DN	Size	Flanschanschluss / Flanged Connection	Einbaumaß Face - to - face	Verbindungsart Connection	Lochanzahl Number of Bolts	Gegen-Flanschdicke counter flange thickness		
							Verbindungsart 1 / Connection 1 Schraube / screw	Verbindungsart 2 / Connection 2 Gewindestange / threaded both
100	4"	PN 6	52	1 oder (or) 2	4	16	4 x M16 x 110	4 x M16 x 130
100	4"	PN 10	52	1 oder (or) 2	8	20	8 x M16 x 120	8 x M16 x 140
100	4"	PN 16	52	1 oder (or) 2	8	20	8 x M16 x 120	8 x M16 x 140
100	4"	JIS 5K	52	1 oder (or) 2	8	16	8 x M16 x 110	8 x M16 x 130
100	4"	JIS 10K	52	1 oder (or) 2	8	18	8 x M16 x 110	8 x M16 x 130
100	4"	JIS 16K	52	1 oder (or) 2	8	22	8 x M20 x 120	8 x M20 x 150
100	4"	ASME B16.5 cl. 150	52	1 oder (or) 2	8	23,9	8 x 5/8"- 11UNC x 130	8 x 5/8"- 11UNC x 150
100	4"	AWWA C 207 cl. B + D	52	1 oder (or) 2	8	12,7	8 x 5/8"- 11UNC x 100	8 x 5/8"- 11UNC x 120
100	4"	AWWA C 207 cl. E	52	1 oder (or) 2	8	23,8	8 x 5/8"- 11UNC x 130	8 x 5/8"- 11UNC x 150
100	4"	AS 2129 - Table D	52	1 oder (or) 2	4	19	4 x M16 x 110	4 x M16 x 140
100	4"	AS 2129 - Table E	52	1 oder (or) 2	8	22	8 x M16 x 120	8 x M16 x 140
125	5"	PN 6	56	1 oder (or) 2	8	18	8 x M16 x 120	8 x M16 x 140
125	5"	PN 10	56	1 oder (or) 2	8	22	8 x M16 x 120	8 x M16 x 150
125	5"	PN 16	56	1 oder (or) 2	8	22	8 x M16 x 120	8 x M16 x 150
125	5"	JIS 5K	56	1 oder (or) 2	8	16	8 x M16 x 110	8 x M16 x 130
125	5"	JIS 10K	56	1 oder (or) 2	8	20	8 x M20 x 120	8 x M20 x 150
125	5"	JIS 16K	56	1 oder (or) 2	8	22	8 x M22 x 130	8 x M22 x 160
125	5"	ASME B16.5 cl. 150	56	1 oder (or) 2	8	23,9	8 x 3/4"- 10UNC x 130	8 x 3/4"- 10UNC x 160
125	5"	AWWA C 207 cl. B + D	56	1 oder (or) 2	8	14,3	8 x 3/4"- 10UNC x 110	8 x 3/4"- 10UNC x 140
125	5"	AWWA C 207 cl. E	56	1 oder (or) 2	8	23,8	8 x 3/4"- 10UNC x 130	8 x 3/4"- 10UNC x 160
125	5"	AS 2129 - Table D	56	1 oder (or) 2	4	21	4 x M16 x 120	4 x M16 x 140
125	5"	AS 2129 - Table E	56	1 oder (or) 2	8	22	8 x M16 x 120	8 x M16 x 150
150	6"	PN 6	56	1 oder (or) 2	8	18	8 x M16 x 120	8 x M16 x 140
150	6"	PN 10	56	1 oder (or) 2	8	22	8 x M20 x 130	8 x M20 x 150
150	6"	PN 16	56	1 oder (or) 2	8	22	8 x M20 x 130	8 x M20 x 150
150	6"	JIS 5K	56	1 oder (or) 2	8	18	8 x M16 x 120	8 x M16 x 140
150	6"	JIS 10K	56	1 oder (or) 2	8	22	8 x M20 x 130	8 x M20 x 150
150	6"	JIS 16K	56	1 oder (or) 2	12	24	12 x M22 x 130	12 x M22 x 160
150	6"	ASME B16.5 cl. 150	56	1 oder (or) 2	8	25,4	8 x 3/4"- 10UNC x 140	8 x 3/4"- 10UNC x 160
150	6"	AWWA C 207 cl. B + D	56	1 oder (or) 2	8	14,3	8 x 3/4"- 10UNC x 110	8 x 3/4"- 10UNC x 140
150	6"	AWWA C 207 cl. E	56	1 oder (or) 2	8	25,4	8 x 3/4"- 10UNC x 140	8 x 3/4"- 10UNC x 160
150	6"	AS 2129 - Table D	56	1 oder (or) 2	8	21	8 x M16 x 120	8 x M16 x 140
150	6"	AS 2129 - Table E	56	1 oder (or) 2	8	22	8 x M20 x 130	8 x M20 x 150

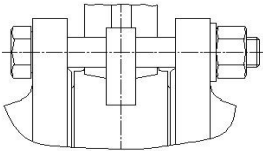
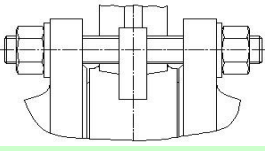
DN	Size	Flanschanschluss / Flanged Connection	Einbaumaß Face - to - face	Verbindungsart Connection	Lochanzahl Number of Bolts	Gegen-Flanschdicke counter flange thickness		
							Verbindungsart 1 / Connection 1 Schraube / screw	Verbindungsart 2 / Connection 2 Gewindestange / threaded both
200	8"	PN 6	60	1 oder (or) 2	8	20	8 x M16 x 120	8 x M16 x 150
200	8"	PN 10	60	1 oder (or) 2	8	24	8 x M20 x 140	8 x M20 x 160
200	8"	PN 16	60	1 oder (or) 2	12	24	12 x M20 x 140	12 x M20 x 160
200	8"	JIS 5K	60	1 oder (or) 2	8	20	8 x M20 x 130	8 x M20 x 150
200	8"	JIS 10K	60	1 oder (or) 2	12	22	12 x M20 x 130	12 x M20 x 160
200	8"	JIS 16K	60	1 oder (or) 2	12	26	12 x M22 x 140	12 x M22 x 170
200	8"	ASME B16.5 cl. 150	60	1 oder (or) 2	8	28,4	8 x 3/4"- 10UNC x 150	8 x 3/4"- 10UNC x 170
200	8"	AWWA C 207 cl. B + D	60	1 oder (or) 2	8	14,3	8 x 3/4"- 10UNC x 120	8 x 3/4"- 10UNC x 140
200	8"	AWWA C 207 cl. E	60	1 oder (or) 2	8	28,6	8 x 3/4"- 10UNC x 150	8 x 3/4"- 10UNC x 170
200	8"	AS 2129 - Table D	60	1 oder (or) 2	8	22	8 x M16 x 130	8 x M16 x 150
200	8"	AS 2129 - Table E	60	1 oder (or) 2	8	25	8 x M20 x 140	8 x M20 x 160
250	10"	PN 6	68	1 oder (or) 2	12	18	12 x M16 x 130	12 x M16 x 150
250	10"	PN 10	68	1 oder (or) 2	12	22	12 x M20 x 140	12 x M20 x 170
250	10"	PN 16	68	1 oder (or) 2	12	22	12 x M24 x 150	12 x M24 x 180
250	10"	JIS 5K	68	1 oder (or) 2	12	18	12 x M20 x 130	12 x M20 x 160
250	10"	JIS 10K	68	1 oder (or) 2	12	22	12 x M22 x 140	12 x M22 x 170
250	10"	JIS 16K	68	1 oder (or) 2	12	24	12 x M24 x 150	12 x M24 x 180
250	10"	ASME B16.5 cl. 150	68	1 oder (or) 2	12	30,2	12 x 7/8"- 9UNC x 160	12 x 7/8"- 9UNC x 190
250	10"	AWWA C 207 cl. B + D	68	1 oder (or) 2	12	17,5	12 x 7/8"- 9UNC x 140	12 x 7/8"- 9UNC x 160
250	10"	AWWA C 207 cl. E	68	1 oder (or) 2	12	30,2	12 x 7/8"- 9UNC x 160	12 x 7/8"- 9UNC x 190
250	10"	AS 2129 - Table C	68	1 oder (or) 2	8	25	8 x M20 x 150	8 x M20 x 170
250	10"	AS 2129 - Table D	68	1 oder (or) 2	8	25	8 x M20 x 150	8 x M20 x 170
250	10"	AS 2129 - Table E	68	1 oder (or) 2	12	25	12 x M20 x 150	12 x M20 x 170
300	12"	PN 6	78	1 oder (or) 2	12	22	12 x M20 x 150	12 x M20 x 180
300	12"	PN 10	78	1 oder (or) 2	12	26	12 x M20 x 160	12 x M20 x 180
300	12"	PN 16	78	1 oder (or) 2	12	28	12 x M24 x 170	12 x M24 x 200
300	12"	JIS 5K	78	1 oder (or) 2	12	22	12 x M20 x 150	12 x M20 x 180
300	12"	JIS 10K	78	1 oder (or) 2	16	24	16 x M22 x 160	16 x M22 x 180
300	12"	JIS 16K	78	1 oder (or) 2	16	30	16 x M24 x 170	16 x M24 x 200
300	12"	ASME B16.5 cl. 150	78	1 oder (or) 2	12	31,8	12 x 7/8"- 9UNC x 170	12 x 7/8"- 9UNC x 200
300	12"	AWWA C 207 cl. B + D	78	1 oder (or) 2	12	17,5	12 x 7/8"- 9UNC x 150	12 x 7/8"- 9UNC x 170
300	12"	AWWA C 207 cl. E	78	1 oder (or) 2	12	31,8	12 x 7/8"- 9UNC x 170	12 x 7/8"- 9UNC x 200
300	12"	AS 4087 class 16	78	1 oder (or) 2	12	30	12 x M20 x 170	12 x M20 x 190
300	12"	AS 2129 - Table E	78	1 oder (or) 2	12	29,0	12 x M24 x 170	12 x M24 x 200
300	12"	AS 2129 - Table D	78	1 oder (or) 2	12	25	12 x M20 x 160	12 x M20 x 180