

## Pneumatic Rotary Actuators Type EBx.1 SYD double-acting

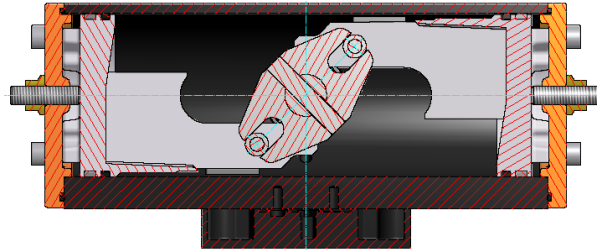

## Type EBx.1 SYS single-acting

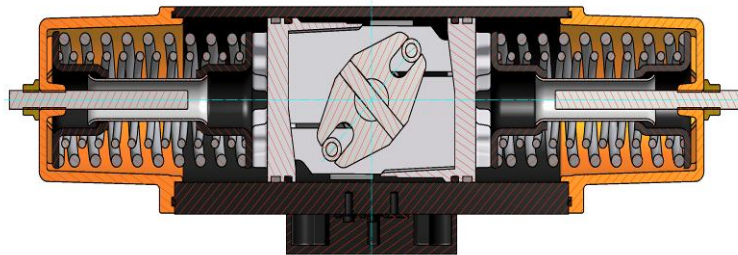

Example illustration, not all possible type variants are shown!

*Language version: English*

## Installation instruction with operating manual and technical appendix in accordance with EU Machinery Directive 2006/42/EC

If required, additional information can be downloaded or ordered from the following addresses:

[www.ebro-armaturen.com](http://www.ebro-armaturen.com)

**EBRO ARMATUREN Gebr. Bröer GmbH**  
Karlstr. 8  
58135 Hagen  
☎ (02331) 904 0



# Contents

	Page
<b>A) GENERAL</b>	<b>3</b>
A1 EXPLANATION OF SYMBOLS	3
A2 CORRECT USE	3
A3 DIVERGENT USE	4
A4 DESIGN OF ACTUATOR	4
A4 IDENTIFICATION OF THE ACTUATOR	6
A5 TRANSPORT AND STORAGE	7
<b>B) MOUNTING THE ACTUATOR ONTO THE VALVE AND CONNECTION OF ADDITIONAL MODULES</b>	<b>8</b>
B1 SAFETY NOTICES FOR ASSEMBLY AND CONNECTION	8
B2 INDIVIDUALLY SUPPLIED ACTUATOR: MOUNTING ONTO THE VALVE	8
B3 ALL ACTUATORS: CONNECTION TO THE COMPRESSED AIR SUPPLY AND OPERATION	9
B4 IF REQUIRED: CONNECTION OF ADDITIONAL ELECTRICAL/PNEUMATIC MODULES TO THE CONTROLLER	11
B5 ALL ACTUATORS: ADJUSTMENT OF THE BASE POSITION <CLOSED>, END STOP SCREWS IN THE END CAPS	11
B6 ALL ACTUATORS, TRIAL RUN: TEST STEPS TO CONCLUDE MOUNTING AND CONNECTION	11
B7 ADDITIONAL INFORMATION: DISMANTLING THE ACTUATOR	12
<b>C) OPERATING INSTRUCTIONS</b>	<b>13</b>
C1 SAFETY NOTICES FOR OPERATION	13
C2 AUTOMATIC OPERATION/ MANUAL OPERATION	13
C3 TROUBLESHOOTING	13
C4 TROUBLESHOOTING	14
<b>D) TECHNICAL APPENDIX/PLANNING DOCUMENTS</b>	<b>15</b>
<b>D1 STANDARD ACTUATOR DESIGN</b>	<b>15</b>
D1-1 ADAPTION TO THE VALVE	15
D1-2 ACTUATOR OUTPUT TORQUES	15
D1-3 ROTATIONAL DIRECTION OF THE ACTUATOR	15
D1-4 VALVE ASSIGNMENT	15
D1-5 SELF-LOCKING WHEN NOT IN OPERATION	15
D1-6 DURABILITY	16
D1-7 MANUAL OPERATION	16
D1-8 INSTALLATION POSITION	16
D1-9 CORROSION PROTECTION	16
<b>D2 OPTIONAL ADDITIONAL EQUIPMENT</b>	<b>16</b>
D2-1 SOLENOID VALVE	16
D2-2 LIMIT SWITCHES (FOR POSITION DETECTION)	16
D2-3 MANUAL OVERRIDE (WITH AUXILIARY GEARBOX)	16
<b>D3 TECHNICAL CHARACTERISTICS OF THE ACTUATOR</b>	<b>17</b>
<b>D4 NOTES ON RISKS ARISING FROM CONTINUOUS OPERATION</b>	<b>17</b>

## A) General

### A1 Explanation of symbols

In this installation manual, notes are marked with the following symbols:

 <b>Warning</b>	<b>Warning</b> ... indicates a situation of immediate danger that could lead to death or severe injury if not avoided.
 <b>Note</b>	<b>Note</b> ... indicates an instruction that should be obeyed without fail.
 <b>Information</b>	<b>Information</b> ... indicates useful tips and recommendations.

### A2 Correct use

Pneumatic rotary actuators type EBx.1 SYD (double acting) and type EBx.1 SYS (with closing or opening springs) are intended,

- after connection of the solenoid valve to a system-side controller,
- with a gaseous control medium (as a rule compressed air) with control pressure in accordance with the type plate,
- under ambient conditions between -20°C and +80°C (EBRO standard), or between -40°C and +140°C (EBRO special designs)
- spring-opening or spring-closing for type EBx.1 SYD with double-action, for type EBx.1 SYS with the “fail safe” function,
- to actuate valves with a 90° rotary motion (e.g. butterfly or ball valves) in response to the electrical signals from the above-mentioned controller and place them in the <OPEN> or <CLOSED> position.
- As a rule, a correctly connected actuator must close in a clockwise direction (looking end-on at the actuator drive shaft) and open in the opposite direction.

The actuator torque and characteristic – see technical appendix – must be matched to the valve and show the valve position correctly with its optical indicator.

To protect the solenoid valve, the compressed air must be filtered with a mesh size of 40µm (ISO 8573-1, class 5). It must be dried and, for switching cycles >4x/min, lightly oiled.

An optionally installed “position detector” module on the actuator signals the actuator position (open/closed) to the system controller.

An optionally installed “position sensor” module on the actuator signals intermediate positions to the system controller so that the valve can be set to intermediate positions between <OPEN> and <CLOSED>.

The actuator be only be operated in accordance with the following documents:

- the <Manufacturer's declaration on EC Directives> included in delivery
- these EBRO mounting instructions **MA4.1 – MRL** (also included in delivery).

The safety instructions in sections B1 and C1 must be observed when installing and operating the drive.

### A3 Divergent use

In agreement with the manufacturer, EBRO-Armaturen, the actuator can be used with media other than compressed air.

### A4 Design of actuator

Type SYD

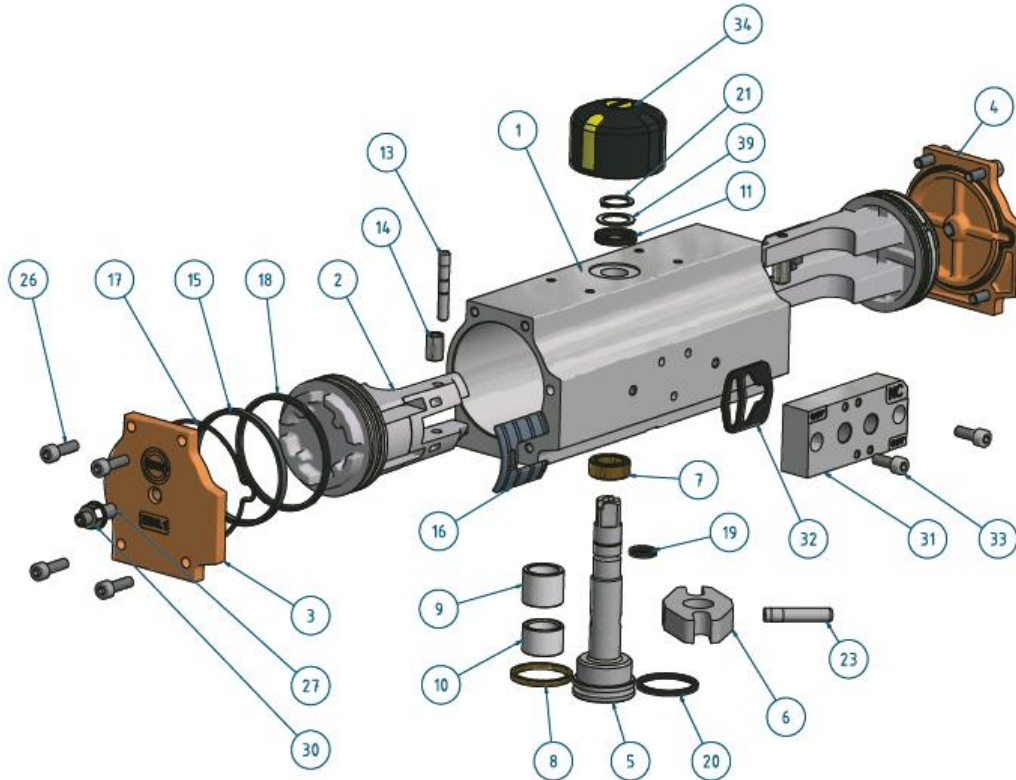

Pt.	Description	Qty.	Material	Pt.	Description	Qty.	Material
1	Actuator cylinder	1	EN AW 6063 - T6	17D	End cover sealing	2	NBR 70
2	Piston	2	EN AC 46000	18D	Piston O-Ring	2	NBR 70
3	End cover L SYD	1	EN AC 46000	19D	O-Ring, upper shaft	1	NBR 70
4	End cover R SYD	1	EN AC 46000	20D	O-Ring, lower shaft	1	NBR 70
5	Drive shaft	1	1.7131	21D	Safety ring	1	1.1248
6	Yoke	1	1.7131 / Sint - D30	23	Bolt	1	1.7225
7	Upper shaft bearing	1	Sint - B50	26	Hex. socket screw	8	A2 - 70
8	Lower shaft bearing	1	Sint - B50	27	Stroke adjusting screw	2	A2 - 70
9	Upper piston bearing	1	technical polymer	30	Seal nut	2	A2 - 70
10	Lower piston bearing	1	technical polymer	31	Valve connection plate	1	EN AC 46000
11	Washer bearing	1	technical polymer	32D	Shaped gasket	1	NBR 70
13	Piston bolt	2	1.7131	33	Hex. socket screw	2	A2 - 70
14	Roller	2	1.3505	34	Position indicator	1	technical polymer
15	Guide band	2	technical polymer	39	Washer	1	A2
16	Slidepad	2	technical polymer				

The spare parts marked with D are integrated in the standard seal set.

Subject to change without notice

# INSTALLATION INSTRUCTION FOR PNEUMATIC ACTUATORS EBx.1 SYD AND EBx.1 SYS

## Type SYS

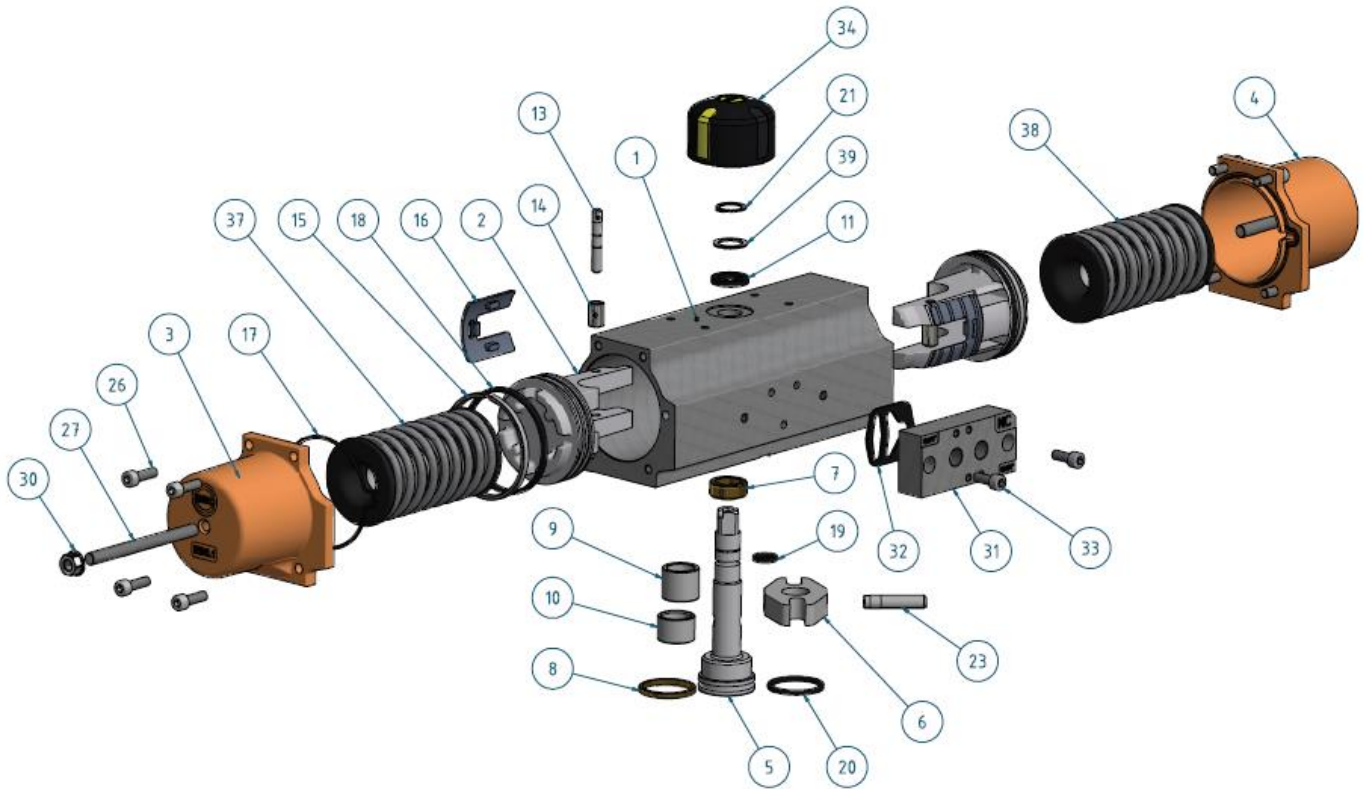

Pt.	Description	Qty.	Material	Pt.	Description	Qty.	Material
1	Actuator cylinder	1	EN AW 6063 - T6	18D	Piston O-Ring	2	NBR 70
2	Piston	2	EN AC 46000	19D	O-Ring, upper shaft	1	NBR 70
3	End cover L SYS	1	EN AC 46000	20D	O-Ring, lower shaft	1	NBR 70
4	End cover R SYS	1	EN AC 46000	21D	Safety ring	1	1.1248
5	Drive shaft	1	1.7131	23	Bolt	1	1.7225
6	Yoke	1	1.7131 / Sint - D30	26	Hex. socket screw	8	A2 - 70
7	Upper shaft bearing	1	Sint - B50	27	Stroke adjusting screw	2	A2 - 70
8	Lower shaft bearing	1	Sint - B50	30	Seal nut	2	A2 - 70
9	Upper piston bearing	1	Technical polymer	31	Valve connection plate	1	EN AC 46000
10	Lower piston bearing	1	Technical polymer	32D	Shaped gasket	1	NBR 70
11	Washer bearing	1	Technical polymer	33	Hex. socket screw	2	A2 - 70
13	Piston bolt	2	1.7131	34	Position indicator	1	techn. Polymer
14	Roller	2	1.3505	37	Spring package	1	FD SiCr / A2
15	Guide band	2	Technical polymer	38	Spring package	1	FD SiCr / A2
16	Slidepad	2	Technical polymer	39	Washer	1	A2
17D	End cover sealing	2	NBR 70				

The spare parts marked with D are integrated in the standard seal set.

Subject to change without notice

**A4 Identification of the actuator**

Every actuator is identified by a type plate:

1. type plate:

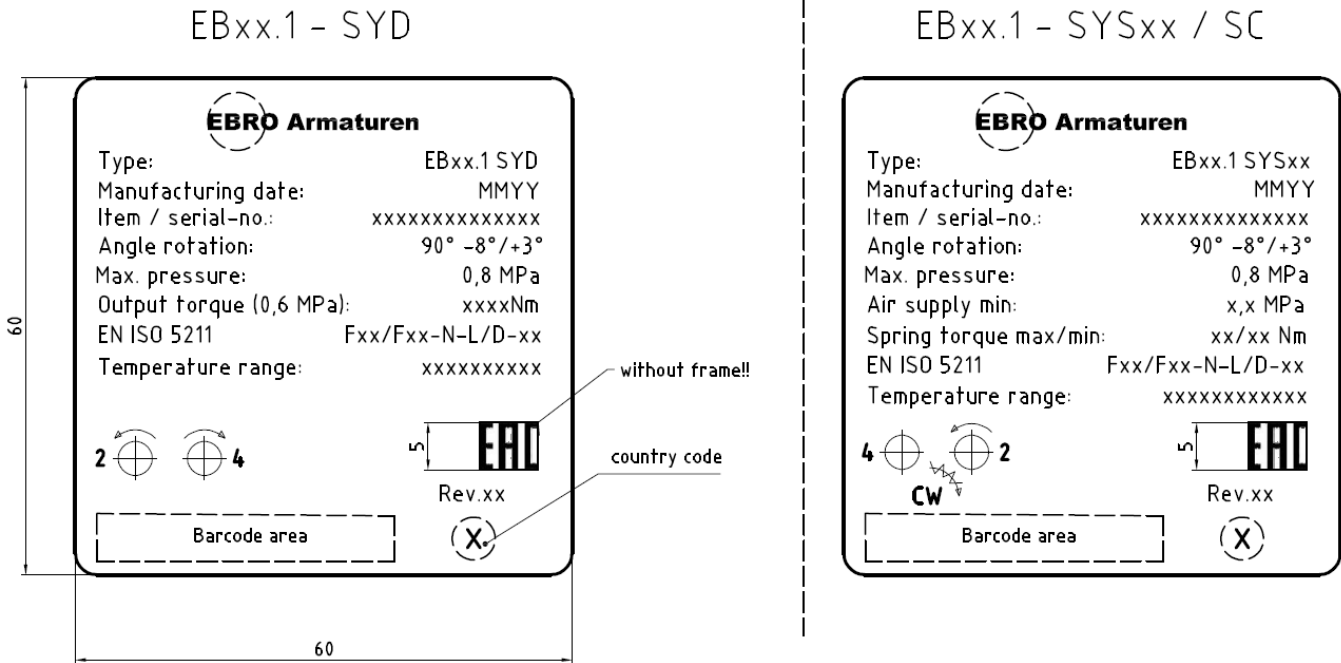

2. type plate:

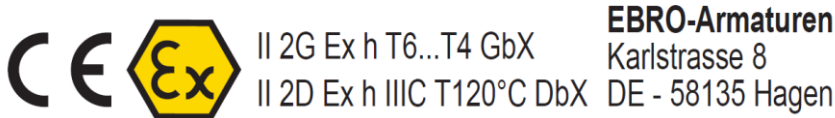

The type plate on the actuator housing must not be covered after mounting the actuator on the valve and after installation in the pipe run – this is to ensure that the actuator remains identifiable.

 <b>Warning</b>	Exceeding the maximum pressure indicated on the type plate endangers subsequent operation.
--------------------	--

## A5 Transport and storage

<b>!</b>	<p>If an actuator is already <u>fitted to a valve</u>:</p> <p>The transport and storage requirements in the valve manual apply. In all cases, the unit is to be stored at constant temperature in an enclosed area.</p>
----------	---

For the correct **transport** of an individually supplied actuator, the following applies:

- Always observe the symbols on the packaging when transporting the packages.
- Until the actuator is put to use (fitted to the valve), keep it in the factory packaging.
- Lay the actuator down on its flat side; any mounted accessories (e.g. solenoid valve/limit switches or manual override) must be positioned to the side or on top.
- Protect the actuator from dirt and moisture.
- If required, use securing belts (not chains) as a transport aid.

In addition for the correct **storage** observe the following instructions:

- All pneumatic or electric connections must be covered
- Coupling parts must be protected with suitable grease or oil
- For long term storage over 12 month, observe the following maintenance work:
  - Functionality and gaskets must be checked every 6 month
  - A functional test must be run at a 6 month interval, acc. to this manual (condition of air, safety instructions, etc.)
  - All gaskets must be changed after 3 years of storage

<b>!</b>	<p>When fitting a belt, ensure that it is not fastened to any add-on modules. Protect the actuator from any damage during transport.</p>
<b>!</b>	<p>Only for special actuators fitted with (manual) override: since the override is, as a rule, heavier than the actuator, the securing belts can also be attached to the override housing (but not to the handwheel!).</p>

### **Product weight:**

(kg)	EB 4.1	EB 5.1	EB 6.1	EB 8.1	EB 8.1	EB 9.1	EB 10.1	EB 12.1	EB 14.1	EB 16.1	EB 18.1	EB 20.1	EB 22.1	EB 26.1
SYD	1,1	1,7	3	4,1	4,4	6,7	7,5	12,7	21,3	29	40,9	57,1	72,5	130,2
SYS		2,4	4,3	6,3	6,6	10,2	12,5	21,1	32,8	48	63,7	94,3	114,9	228,6

## **B) Mounting the actuator onto the valve and connection of additional modules**



*These instructions include safety notices for foreseeable risks when mounting the actuator onto a valve.*

It is the user's responsibility to supplement these instructions for other risks, especially those arising with specific valves. It is assumed that all requirements for this system have been met.

The connection of any additional electric/electro-pneumatic modules supplied with the actuator is described in the accompanying documentation.

These documents apply in addition to these instructions.

### **B1 Safety notices for assembly and connection**



- The assembly and pneumatic/electrical connection of an actuator to the operator's system(s) may only be carried out by trained specialists. For the purposes of this manual, trained specialists are persons who, on the basis of their training, specialist knowledge and professional experience, are familiar with pneumatic components and can correctly assess and execute the work assigned to them and can identify and avoid potential risks.

A knowledge of the typical properties of rotary valves (butterflies, ball valves) is also required for the assembly; assembly and connection should, where appropriate, be carried out in collaboration with expert colleagues.

- Actuators are not "stepladders". External loads must not be applied to the valve, actuator or feed lines.
- Commissioning of an actuator assembled to a valve is not permitted until the valve is enclosed on both sides by a section of pipe or equipment – any prior actuation implies a risk of crushing and is the sole responsibility of the user.



**Risk of crushing!**

The installation of equipment at the upper end of the shaft is only permitted if it is intended for this purpose. Limit switch boxes and sensors for limit position monitoring or positioner (position regulator for modulating operation) are permitted for installation.

Installation of a hand lever for manual override or other accessories creating a crushing hazard are not permitted.

If extended limiting screws for travel stop are in use, after mounting and adjusting the screws must be shortened (max. 10 mm sticking out) or use an adequate protection against injuries.

### **B2 Individually supplied actuator: mounting onto the valve**

- Depending on the valve position, use standard tools via the outer square of the drive shaft - depending on the position of the valve to bring the actuator to the <CLOSED> or <OPEN> position, seat and centre the actuator on the valve.  
The position of the actuator on the valve must be selected depending on the valve.
- The screw connection must be tightened sufficiently for the actuating torque to be transmitted by frictional forces – see table below. The flange size for the actuator is specified on the type plate.  
Tighten screws cross-wise.

ISO flange size	F04	F05	F07	F10	F12	F16
Tightening torque [Nm]	5-6 Nm	8-10 Nm	20-23Nm	44-48 Nm	78-85 Nm	370-390 Nm



- The position indicator must be adjusted to match the valve position:
  - ▶ pointer perpendicular to pipe axis: valve is closed
  - ▶ pointer parallel to pipe axis: valve is open



**Warning**

An incorrect position indication presents a danger for subsequent operation.

### **B3 All actuators: connection to the compressed air supply and operation**



At the start of assembly, you must ensure that the system – data control pressure, control voltage and frequency – for all modules comply with the technical data given on the type plates of the actuator and the additional modules.

The connection of air supply is acc. VDI/VDE 3845 (Namur) for sizes EB4.1 to EB18.1 with G 1/4" thread. The sizes EB20.1 to EB26.1 are equipped with G1/2" thread. All sizes EB4.1 – 12.1 are equipped with a Namur plate for reverse operation. In the basic version, the closing direction NC (normally closed) is marked by the orientation of the plate with the beveled corner at the top right.

The **minimum permissible actuating** time is **0.1 seconds for actuator types EB4.1-12.1 and 0.3 seconds for EB14.1-26.1**. The actuating time refers to a uniformly accelerated rotary movement over 90° in the two actuating directions opening and closing. Blocking in the end positions or during actuation must be avoided at all times. This must be ensured at all times by suitable external control and the selection of suitable valves depending on the process conditions.

The control diagrams for

- ▶ double-acting actuators EBx.1 SYD are shown in Fig. 1
- ▶ single-acting actuators with spring reset EBx.1 SYS are shown in Fig. 2.

For further information, see the instructions for the solenoid valve.

The connection diagrams in accordance with VDI/VDE 3845 (Namur) feature a G ¼" thread

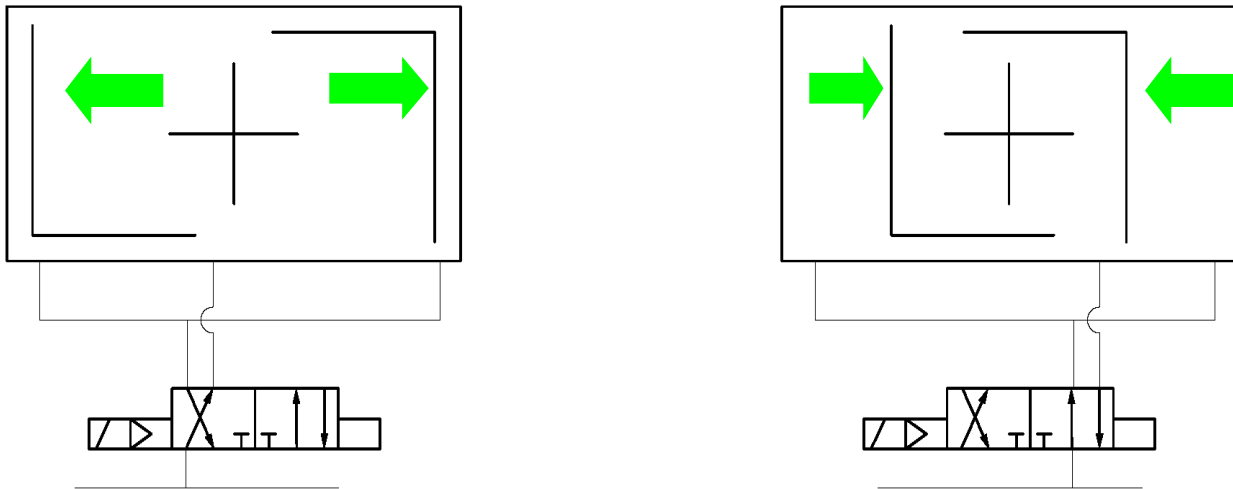

**Figure 1: Fig. 1: Schematic diagrams for double-acting actuators EBx.1 SYD**

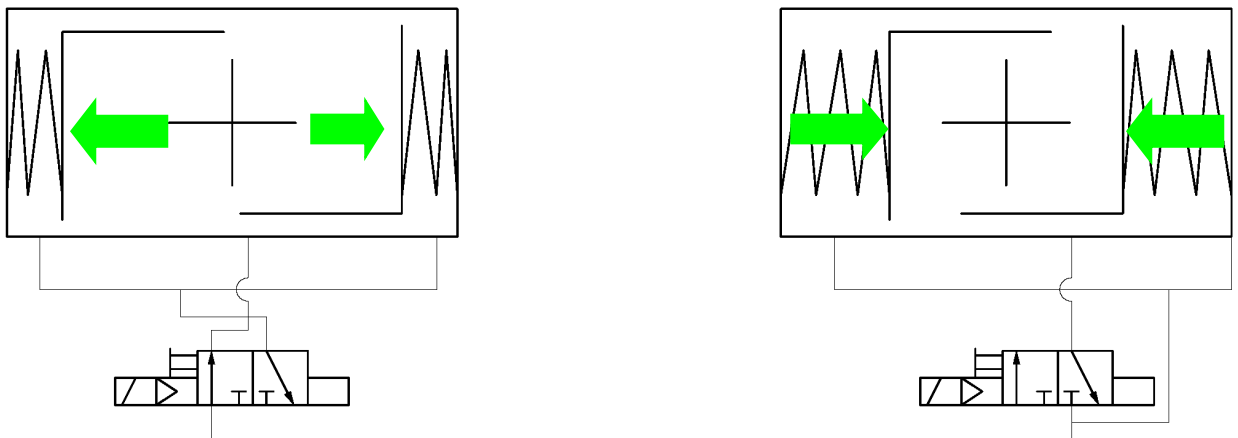

**Fig. 2: Schematic diagrams for single-acting actuators EB SYS**



In the standard version of the actuator, feeding control air to the **left connection** will cause an **anticlockwise motion**; feeding to the **right connection** will cause a **clockwise motion**.  
**Spring-reset actuators** are to be fed only via the **right connection**; see fig. 2

**B4 If required: connection of additional electrical/pneumatic modules to the controller**

If such modules are to be connected, the instructions supplied by the component manufacturer must be observed.

**B5 All actuators: adjustment of the base position <CLOSED>, end stop screws in the end caps**

***This section is only applicable if the valve manufacturer has not already exactly adjusted the <CLOSED> and <OPEN> positions.***

*The end stop in the actuator is adjusted for the <CLOSED> position ex works: If required: adjust stop screw.*

 <b>Warning</b>	The end positions may only be adjusted when the actuator is depressurised!
---	--

- Loosen both sealing nuts, loosen the end stop screws by a few turns.
- Change the piston position by turning the drive shaft until the groove of the square shaft lies parallel to the longitudinal axis of the cylinder.
- Screw in the end stop screws on both sides until you can feel resistance and tighten the sealing nuts.

**B6 All actuators, trial run: test steps to conclude mounting and connection**

To ensure flawless operation of the actuator during automated operation, the following tests must be carried performed **on each actuator/valve unit** after mounting:

- Does the position indicator on the actuator match the valve position?

If not, the indicator position must be readjusted.

 <b>Warning</b>	Incorrect position feedback (and incorrect optical display) presents a danger for subsequent operation.
---	---

- Is the control pressure sufficient at the point of use?

The control pressure directly at the solenoid valve should be at least that shown on the actuator type plate and the smooth operation of a valve under operating conditions ensured.

- Is the solenoid valve correctly connected?

If control pressure is present but the control signal fails (to test, for example, pull out the plug), the valve must move into the position specified by the purchaser:

Actuator type	Type ID	the valve must
double-acting	EBx.1 SYD	<i>Unless otherwise specified in the order:</i> move into the “CLOSED” position.
spring-closing	EBx.1 SYS	move into the “CLOSED” safety position.
spring-opening		move into the “OPEN” safety position.

If this is not the case, the drive control and/or connection of the solenoid valve must be corrected accordingly. Remedy: see section C3. Troubleshooting

- Actuator/valve connection correctly tightened?

In functional testing, no relative movement between the valve, mounting bracket (if present) and pneumatic actuator should be detectable. If necessary, re-tighten all screws on the flange joint – see table in section B3.

- Testing actuation function and display:

when control pressure is applied, the control commands “**CLOSED**” and “**OPEN**” must cause the valve **to move into the corresponding end positions**. The optical display on the actuator (and on the valve, if applicable) must show this correctly.

If this is not the case, the actuator control and/or the indicator position must be corrected accordingly.

- Check electrical position feedback (if module present)

the electrical signals “**OPEN**” and “**CLOSED**” (in the system-side control centre) must be compared with the display on the valve. **Signal and display must agree**. If this is not the case, the control and/or the adjustment of the position detector must be checked. The component manufacturer’s installation instructions must also be complied with.

### **B7 Additional information: dismantling the actuator**

The same safety rules are to be observed as for the piping system, the compressed air supply and the (electrical/electro-pneumatic) control system.

Carry out the following steps:

- Mark the alignment between actuator and valve position and record it for reassembly.
- Shut off the compressed air supply safely – if necessary, depressurise the valve.
- Disconnect compressed air supply and control connections.
- Loosen actuator/valve flange joint and lift actuator off the valve.



## C) Operating instructions

In accordance with MRL 2006/42/EC, manufacturers must compile a comprehensive risk analysis. EBRO-Armaturen provides the following documents for this purpose:

- these mounting and operating instructions,
- the included DECLARATION OF INCOPORATION OF PARTLY COMPLETED MACHINERY

	<p><i>These instructions include safety notices for foreseeable risks arising when using the actuator in industrial applications..</i></p> <p>It is the user's responsibility to supplement these instructions for other risks, especially those arising with specific valves.</p>
---	--

### C1 **Safety notices for operation**

	<ul style="list-style-type: none"> <li>• The function of a valve-mounted pneumatic actuator must comply with the &lt;correct use&gt; described in section A2.</li> <li>• The conditions of use must comply with the conditions shown on the actuator type plate.</li> </ul> <p>A standard version actuator may only be operated within the temperature limits of -20 °C and +80 °C (EBRO standard).</p> <ul style="list-style-type: none"> <li>• Any work on the actuator may only be carried out by trained personnel. For the purposes of this manual, trained specialists are persons who, on the basis of their training, specialist knowledge and professional experience, can correctly assess and execute the work assigned to them and can identify and avoid potential risks.</li> </ul>
 <b>Risk of crushing!</b>	<p>Operation of an actuator mounted on a valve is only permissible if the valve is enclosed on both sides by a section of pipe or equipment – any prior actuation entails a risk of crushing and is the sole responsibility of the user.</p>

### C2 **Automatic operation/ manual operation**

If the actuator is correctly mounted as described in section B, it works automatically and is designed for continuous operation, in accordance with DIN EN 15714-3:2010-02, Table 1.

	<ul style="list-style-type: none"> <li>• When pneumatically powered, the actuator requires a continuous supply of compressed air to ensure stable operation.</li> <li>• If the compressed air supply is interrupted or switched off, &lt;fail safe&gt; actuators move the valve in the predetermined CLOSED or OPEN position.</li> </ul>
---	--

### C3 **Troubleshooting**

Before carrying out troubleshooting procedures, please take note of the safety notices for mounting and repair work. Troubleshooting procedures should only be carried out by trained personnel.

Any tools used must comply with the relevant regulatory requirements and be in perfect condition. Before the rotary actuator is dismantled for troubleshooting, the responsible operations department must give its work clearance. The troubleshooting table below describes a selection of causes of faults that may occur, according to experience, and the corresponding corrective measures:

Fault	Cause	Corrective measure
Rotary actuator does not respond	Power supply to 5/2-way solenoid valve interrupted	(Re-)establish supply; carry out functional test
	Control medium supply interrupted	(Re-)establish control medium supply; carry out functional test
	Actuator control pressure too low	Check control medium supply (adjust if necessary); carry out functional test
	Solenoid valve defective	Disconnect solenoid valve and replace or repair; carry out functional test
	Valve defective (sticks)	See troubleshooting for valves
	Actuator defective (loss of control pressure)	Dismantle actuator and repair; remount actuator; carry out functional test
Rotary actuator cannot be moved to end positions	Stop screws misaligned	Adjust stop screws; carry out functional test
	Valve defective (sticks)	see manufacturer's troubleshooting guide

#### **C4 Troubleshooting**

##### **General:**

Please note the standard instruction and the additional for ATEX (BA 4.1 – ATEX/MRL).

## **D) Technical appendix/planning documents**

### **Note:**

Notice: This appendix is not a part of the <Original Mounting Instructions>, it simply provides supplementary information.

The planner/purchaser must ensure that the actuator is suitable for

- ▶ the valve on which it is mounted,
- ▶ the system-side compressed air supply and the control system.

Important relevant technical information in this respect is listed below.

### **D1 Standard actuator design**

#### **D1-1 Adaption to the valve**

The pneumatic rotary actuators type EBx.1 SYD (double-acting) and Typ EBx.1 SYS (with opening/closing spring) can be mounted on all rotary action (90°) valves which have an assembly flange complying with DIN EN ISO 5211.

#### **D1-2 Actuator output torques**

For drive torques for all types, please refer to the technical data sheet (catalog sheet), available at [www.ebro-armaturen.com](http://www.ebro-armaturen.com).



*The actuator torque varies according to the effective air pressure applied to the actuator.*

- ▶ The actuator is designed to withstand overpressures up to 8 bar,
- ▶ Underpressures must be taken into account by the planner/purchaser when selecting the actuator size.

#### **D1-3 Rotational direction of the actuator**

Design standard DIN EN 15714-3:2010-02 specifies that the valve should close in a clockwise direction. This must be ensured during installation by correct connection of the solenoid valve to the power supply and control – see also section B4. The solenoid valve documentation must supply the required information.

#### **D1-4 Valve assignment**

The main factors influencing the required actuation torque are the valve (nominal size), the working pressure and the medium. The required actuation torque for the valve, which is to be provided by the valve manufacturer, derives from these parameters.

It is recommended that a safety margin be added to this value for the configuration of the actuator.

#### **D1-5 Self-locking when not in operation**

The actuation torque – as given in the technical data in section D3 – is achieved by

- ▶ All double-acting rotary actuators, only when control pressure is applied
- ▶ and all <fail safe> actuators with spring returns at the end points.

**As a general rule, the hydraulic torque of the medium cannot influence the position of the shut-off device.**

## D1-6 Durability

Configuring the actuator in accordance with DIN EN 15714-3:2010-02, Table 1 is the requirement for type testing of the actuator in endurance testing at 30% of nominal power under laboratory conditions. The operating conditions will determine if and when the actuator requires servicing, especially the pressure and purity of the compressed air.



*As a general rule, the service interval of an actuator is significantly longer than that of the valve.*  
▶ When the valve is serviced, the actuator should at least be checked to ensure it is functioning correctly.

## D1-7 Manual operation

Manual operation using an auxiliary gearbox with a free-wheel is not standard for pneumatic actuators.

## D1-8 Installation position

The valve/actuator unit may be installed in any position.

- ▶ The usual position is with the actuator above the valve
- ▶ The valve type may restrict the possible installation positions
- ▶ If the valve shaft of a unit with additional manual operation gearbox is mounted horizontally, the system designer or valve manufacturer must decide whether the actuator exerts an unacceptable bending stress on the valve and/or an inadmissible torsional moment is applied to the flange connection and to the piping, and whether this requires additional support.

## D1-9 Corrosion protection

This unit corresponds to corrosion category C4, as set out in the DIN EN 15714-3:2010-02 standard for pneumatic actuators.

## D2 *Optional additional equipment*

### D2-1 Solenoid valve

At the customer's request, the actuator can be supplied fitted with a solenoid valve – the valve manufacturer, voltage and current type (DC or AC) must be specified.

### D2-2 Limit switches (for position detection)

At the customer's request, the actuator can be supplied fitted with 2 (or more) limit switches to signal "OPEN" and "CLOSED" – the manufacturer, voltage and current type (DC or AC) must be specified for the magnet.

### D2-3 Manual override (with auxiliary gearbox)

At the customer's request, the actuator can be supplied fitted with a worm gearbox with a manually operated clutch.





### D3 Technical characteristics of the actuator

For technical details please refer the technical specification sheet [www.ebro-armaturen.com](http://www.ebro-armaturen.com)

### D4 Notes on risks arising from continuous operation

- The actuator is designed for continuous operation, in accordance with DIN EN 15714-3:2010-02, Table 1.
- The actuator is screwed to the valve at the interface as per ISO5211. The necessary tightening torques for the fastening screws can be found in Section B2.  
Actuators with higher actuation frequencies should be visually inspected at suitable intervals (no later than when the valve is serviced) to check that this screw fastening remains tight – it should be tightened if required.
- The actuator is designed for operation with clean and dry compressed air in accordance with section 1 <Correct use>.

	The material selection and manufacturing tolerances of the valve drive shaft interface must be matched to the frequency of the switching operations <u>by the valve manufacturer</u> – in accordance with the requirements of EN 5211:
	As a rule, the <CLOSED> position of the valve is adjusted when the actuator is mounted onto the valve. As long as the valve does not leak, this setting should not be changed. If adjustment is necessary, the EBRO assembly instructions, <b>MA4.1-MRL section B6</b> , and/or the relevant valve manual provide more precise information.

### D5 Notes on other risks

- *Securing the pretensioned springs:*  
The spring sets of type EBx.1 SYS are pretensioned and appropriately secured. The protective sleeve must not be altered by the user. Springs must not be exposed to corrosive control media.
- *Replacing spring sets:*  
If required, the spring sets of type EBx.1 SYS can be changed to meet the torque requirement of the valve.
- *Mechanical loads:*
  - ▶ Actuators are not “stepladders”. External loads must not be applied to the valve, actuator or feed lines.
  - ▶ The actuator is designed for static loading within the piping system. Risks arising from loading caused by vibrations in the system are not covered: in such cases, the long-term securing of the screw fastenings on the actuator, at the least, must be agreed with the manufacturer, EBRO-Armaturen.

## D6 Speed control block

The pneumatic speed control block is an optional module.

All blocks are equipped with two separate throttles for limiting the air flow for the actuator.

All blocks are designed for mounting between actuator and additional equippend acc. to the standard Namur-port.

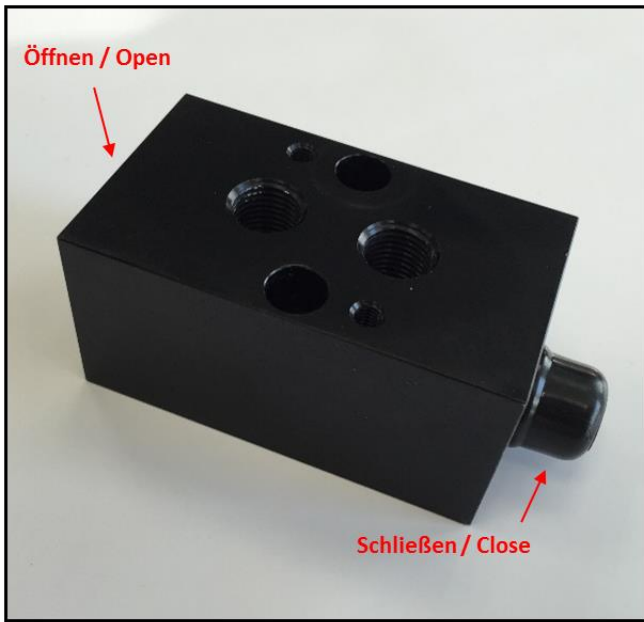

Double acting speed control block  
**No namur connection plate required!**

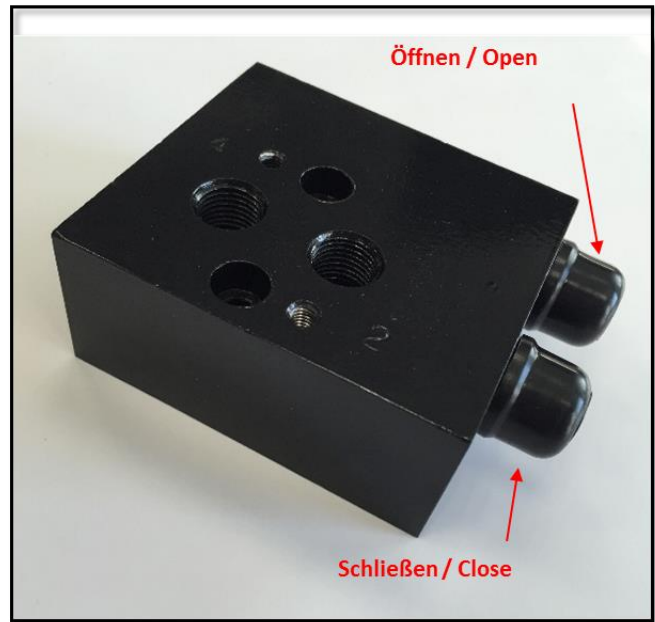

Single acting speed control block  
**No namur connection plate required!**

## DECLARATION OF INCORPORATION OF PARTLY COMPLETED MACHINERY

EE\_EB01

Rev02/2020-10

The manufacturer

**EBRO ARMATUREN Gebr. Bröer GmbH**

**Karlstraße 8  
DE 58135 Hagen**

declares that pneumatic part turn actuators

**Type EBx.1 SYD double acting  
Type EBx.1 SYS single acting**

- are manufactured in accordance with the requirements of the following standards:

<b>DIN EN ISO 5211:2017-08</b>	<b>Industrial valve part-turn actuator attachment</b>
<b>DIN EN 15081:2008-03</b>	<b>Mounting kits for part-turn valve actuator attachment</b>
<b>VDI/VDE 3845 :2010-09</b>	<b>Interfaces of valves and auxiliary equipment</b>
<b>DIN EN ISO 12100:2011-03</b>	<b>Safety of machinery</b>
<b>ISO 8573-1:2010-04 Cl. 3 and 5</b>	<b>Compressed air – contaminants and purity classes</b>

and

- the specific technical documentation has been prepared in accordance with Annex VII, Part B.
- the specific technical documentation referred to in Annex VII, Part B is supplied in written form or digitally (pdf) in response to reasoned requests from national authorities.

The following product documents are available:

**Technical documentation, installation instruction BA-4.1\_EB**

These products conform to the following directives:

### **Machinery Directive 2006/42 EG (MRL)**

1. The products are an "incomplete machine" in the sense of article 2 g) of this directive
2. The table overleaf lists whether and how the requirements of this directive are fulfilled
3. This declaration is the mounting declaration in the sense of this directive

For conformity with the above- named directives, the following apply:

1. The user must comply with the <correct use> as defined in the "installation instruction" (BA-4.1\_EB) included in the delivery and must follow all notices in these instructions. Failure to comply with these instructions can – in serious cases – release the manufacturer from product liability.
2. Commissioning of this partly completed machinery is not permitted until conformity of the system in which the actuator is installed with all the above- mentioned EC directives is declared by the person responsible. A specific declaration is included in delivery for the above - named actuator.
3. The manufacturer, EBRO ARMATUREN, has carried out and documented the required risk analyses. The employee responsible for making this documentation available is Mr. Matthias Jortzik, EBRO ARMATUREN Gebr. Bröer GmbH, Karlstraße 8, 58135 Hagen, Germany.

Hagen, 16 November 2020

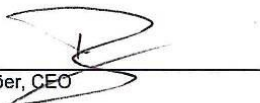
  
Lydia Bröer, CEO

EBRO ARMATUREN Gebr. Bröer GmbH  
Karlstraße 8  
DE 58135 Hagen



# INSTALLATION INSTRUCTION FOR PNEUMATIC ACTUATORS EBx.1 SYD AND EBx.1 SYS

<b>The manufacturer</b>	<b>EBRO ARMATUREN Gebr. Bröer GmbH, D58135 Hagen</b>
<b>declares that the EBRO pneumatic actuators EBx.1 SYD/SYS meet the following requirements:</b>	
<b>Requirements according to appendix I, Machinery Directive 2006/42/EC</b>	
1.1.1., g) Correct use	See installation instruction
1.1.2., c) Incorrect use warnings	See installation instruction
1.1.2., c) Required protective equipment	Exactly as for the pipe section in which the valve is installed
1.1.2., e) Accessories	No special tool is required for changing wearing parts
1.1.3 Components in contact with media	The materials of the parts in contact with media are determined before delivery and are specified both in the type data sheet and the EBRO confirmation of order. The user is required to carry out an appropriate risk analysis for resistance to the operating medium.
1.1.5 Handling	Fulfilled by the notices in the installation instructions
1.2 and 6.2.11 Control	The user's responsibility, and in accordance with the installation instructions for the actuator
1.3.2 Prevention of breakage risks	For functional components: assured if actuator correctly used
1.3.4 Sharp corners and edges	Requirement fulfilled
1.3.7/8 Injury caused by moving parts	Requirement fulfilled if correctly used. Service and repair are only permissible with actuator deactivated and power supply switched off.
1.5.1–1.5.3 Power supply	The responsibility of the user. See also installation instructions for the actuator
1.5.5. Operating temperature	Warning notice against unacceptable temperatures: see Installation instruction, section <correct use>
1.5.7 Explosion	 protection required. Must be expressly agreed in purchase order. In this case: use only as marked on the actuator.
1.5.13 Emission of hazardous substances	Not applicable
1.6.1 Servicing	See installation instruction Holding of spare part stock to be agreed with with EBRO Armaturen.
1.7.3 Identification	Valve: in accordance with assembly instructions. Actuator: see actuator manufacturer's documentation.
1.7.4 Operating instructions	These installation instructions also contain instructions for the use of the actuator. Additional information required for the operation of the <complete machine> is the responsibility of the planner/user.
<b>Appendix III</b>	The actuator is not a <complete machine>: therefore it has no CE marking for conformity with the Machinery Directive
<b>Appendices IV, VIII-XI</b>	Not applicable
<b>in accordance with DIN EN ISO 12100: 2011-03</b>	
1. Area of application	The basis for this is decades of experience of use of the actuator types named on page 1 <i>Note: it is essential that the user carries out a risk analysis of the pipe run and the valves installed therein that is specially adapted to the operating conditions in accordance with sections 4 to 6 of DIN EN ISO 12100: 2011-03 – such an analysis is not possible for the manufacturer, EBRO Armaturen in respect of standard valves.</i>
3.20.6.1 Inherently safe design	The actuators are manufactured according to <inherently safe design> principles.
Analysis according to sections 4, 5 and 6	Experience of faulty operation and misuse documented by the manufacturer in the context of cases of damage (documentation in accordance with ISO9001) was used as the basis.
5.3 Limits of the machine	Limiting of the <incomplete machine> was carried out in accordance with the <correct use> of the actuator.
5.4 Decommissioning, disposal	Not within the responsibility of the manufacturer, EBRO Armaturen
6.2.2 Geometric factors	Since the valve and actuator comprise the functional parts, when correctly used, this section does not apply.
6.3 Technical protective devices	Where applicable, only required for accessories – see confirmation of order.
6.4.5 Operating instructions	Since valves with actuators work automatically, following the command signals from the controller, the installation instruction describes those aspects that are <typical of the actuator> and must be provided to the manufacturer of the piping system.
Risk analysis	The risk analysis was carried out in accordance with MRL appendix VII, B) by the manufacturer, EBRO Armaturen and is documented in accordance with MRL appendix VII B).